

CATALOGO 2023



EL DISPLAY PUBLICITARIO HA SIDO DE GRAN AYUDA EN EL MUNDO DE LA PUBLICIDAD Y EL ARTE DIGITAL

La promoción de una marca e incluso el arte digital se presentan de una manera fácil y eficaz gracias a la gran variedad de expositores que se manejan en el mercado.

En Exhideas, ofrecemos los displays más innovadores y completos, adaptándose a las necesidades de nuestros clientes y ayudando a que la comunicación entre marca y público sea exitosa.

Estos pueden tener uso en diferentes áreas;
Eventos, Puntos de ventas, Promotoras, etc.



ROLL UP
1

X-BANNER
9

FLYING BANNER
21

DEMO STAND
28

MURO/PARED
37

REVISTEROS
44

TOLDOS
51

COLGANTES
57

STAND PACK
61



ROLL UP

Especial para interiores

Se destaca por su fácil instalación
es autoenrollable
Hecho de aluminio ligero
El gráfico se adhiere por la parte inferior
y una pinza lo sujeta por la parte superior



*Maleta incluida



ROLL UP 85*200

Código: RU-85

Roll up sencillo
Medidas: 85cm * 200cm
Se puede montar en tela, lona
o papel fotográfico

Peso: 2.3kg



ROLL UP ECONÓMICO

Código: RU80-ECO

Display Publicitarios

Roll up económico
Medidas: 80cm * 200cm
Especial para interiores

Peso: 2kg



*Maleta incluida



ROLL UP DOBLE

Código: RU- 85 D

Roll up doble vista
Ideal para dos gráficos
Medida: 85cm * 200cm

Peso: 5.5kg

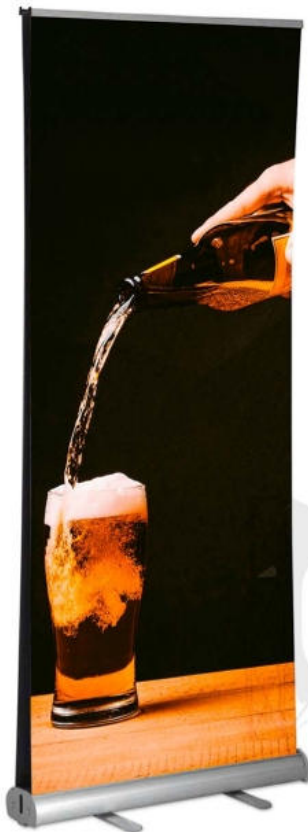

*Maleta incluida



ROLL UP 120*200

Código: RU-120

Roll up mediano
Medida: 120cm * 200cm

Peso: 3.4kg

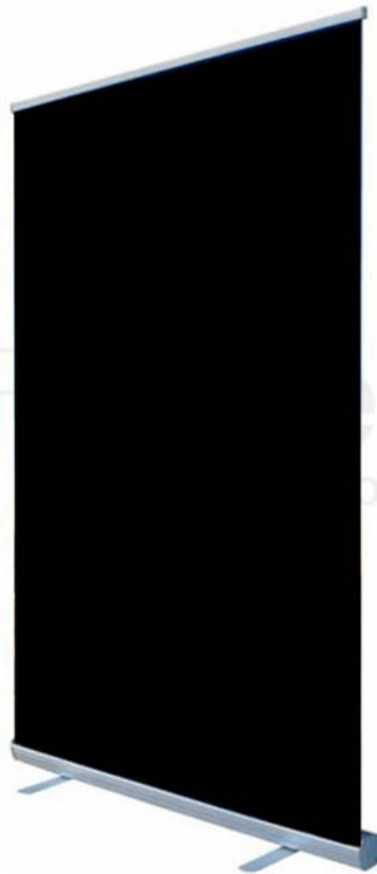

*Maleta incluida



ROLL UP 200

Código: RU-200

Roll up grande

Medida: 200cm * 200cm

Debido a su tamaño, puede sustituir un muro publicitario

Peso: 7.5kg

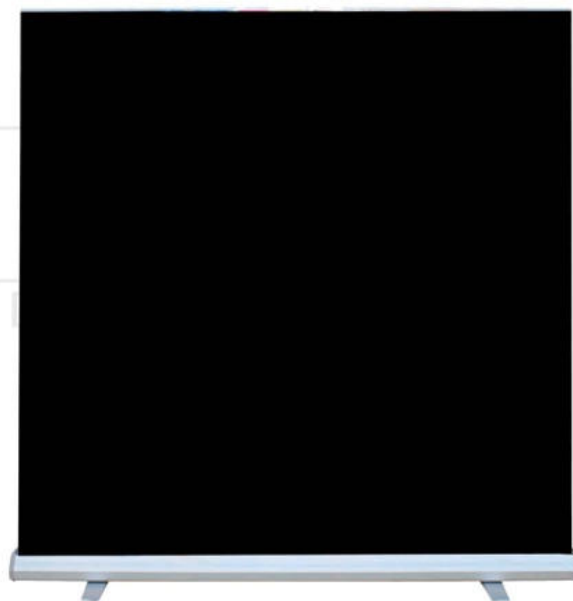

*Maleta incluida





ROLL UP 240

Código: RU-240

Roll up extra grande
Medida: 240cm * 200cm
Debido a su tamaño puede
sustituir un muro publicitario

Peso: 8.9kg



*Maleta incluida



MINI ROLL UP A4

Código: RU- M

Roll up tamaño A4 (21*30cm)

Para escritorio o stands

Peso: 0.3kg



MINI ROLL UP A3

Código: RU-M3

Roll up tamaño A3 (30*42cm)

Para escritorio o stands

Peso: 0.4kg





X-BANNER

Especial para interiores

Estructura clásica en forma de X
Hecho de aluminio / fibra de vidrio
Para tela o lona



X-BANNER ECO

Código: ECO-X 80

X-Banner económico
Hecho de fibra de vidrio
Ligero y resistente
Medida: 80cm * 180cm

Peso: 1kg



*Bolsa de transporte incluida

X-BANNER ECO

Código: ECO-X 60

X-Banner económico
Hecho de fibra de vidrio
Ligero y resistente
Medida: 60cm * 160cm

Peso: 1kg



X-BANNER REFORZADO ECONÓMICO

Código: X-R 60 ECO

Estructura reforzada de fibra de vidrio

Ligero y resistente

Medida: 60cm * 160cm



Tubos gruesos

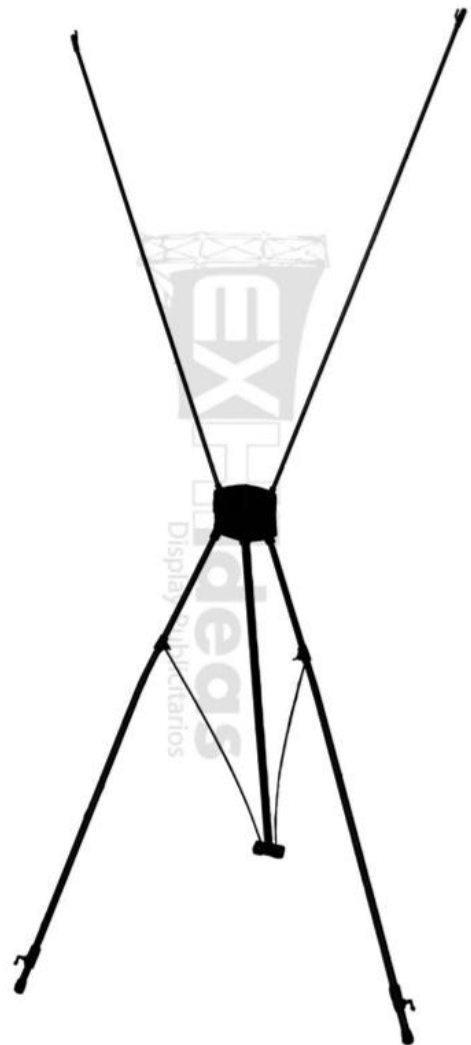

X-BANNER REFORZADO

Código: X-R 60

X-Banner reforzado

Medida: 60cm * 160cm

Hecho de aluminio y fibra de vidrio

Peso: 1kg

X-BANNER REFORZADO

Código: X-R 80

X-Banner reforzado

Medida: 80cm * 180cm

Hecho de aluminio y fibra de vidrio

Peso: 1kg

X-BANNER REFORZADO

Código: X-R 120

X-Banner reforzado

Medida: 120cm * 200cm

Hecho de aluminio y fibra de vidrio

Peso: 1kg



*Bolsa de transporte incluida





X-BANNER TIPO D

Código: X-BANNER D

X-Banner reforzado tipo D
Medidas ajustables: 60cm * 160cm y 80cm * 180cm
Hecho de aluminio y fibra de vidrio

Peso: 1kg

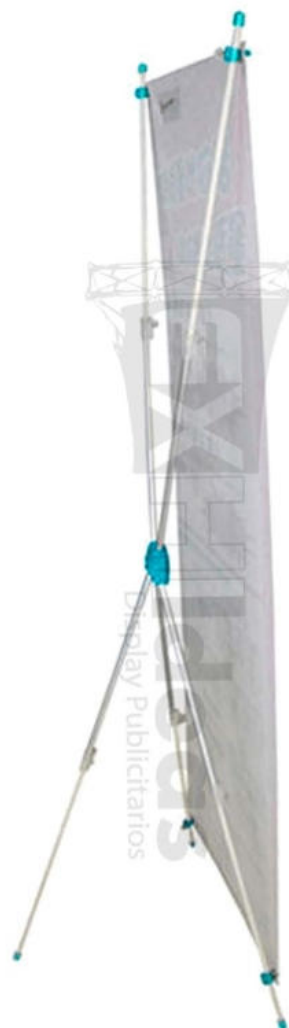
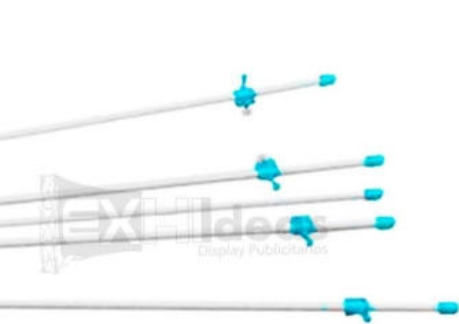

*Bolsa de transporte
incluída





L-BANNER

Código: L-BANNER

Banner en forma de L
Medida: 80cm * 200cm
Hecho de aluminio puro

Peso: 1kg



*Bolsa de transporte incluida





BANNER EXTERIOR

Código: BEA

Banner base rellenable
Para agua o arena
Medida: 80cm * 180cm
Estructura de doble vista
Hecho de acero y plástico
Especial para exteriores

Peso: 2.6kg



*Con bolsa de transporte incluida





X-BANNER BASE AZUL

Código: X-B EXT

X-Banner Base Rellenable para agua o arena

Medidas: 60cm * 160cm y 80cm * 180cm

Hecho de aluminio, fibra de vidrio y plástico

Estructura de doble vista

Especial para exteriores

Peso: 15kg (con base rellena)

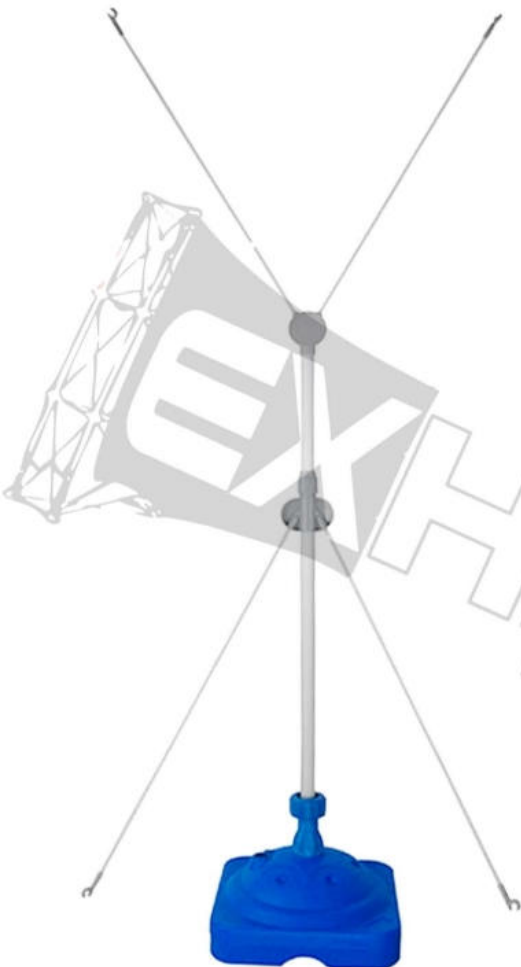

*Bolsa de transporte incluida





X-BANNER EXTERIOR

Código: X-B EX DELUX

X-Banner base rellenable para agua o arena
Medidas ajustables: 60cm * 160cm y 80cm * 180cm
Estructura doble vista
Hecho de aluminio, fibra de vidrio y plástico
Especial para exteriores

Peso: 15kg (con base rellena)

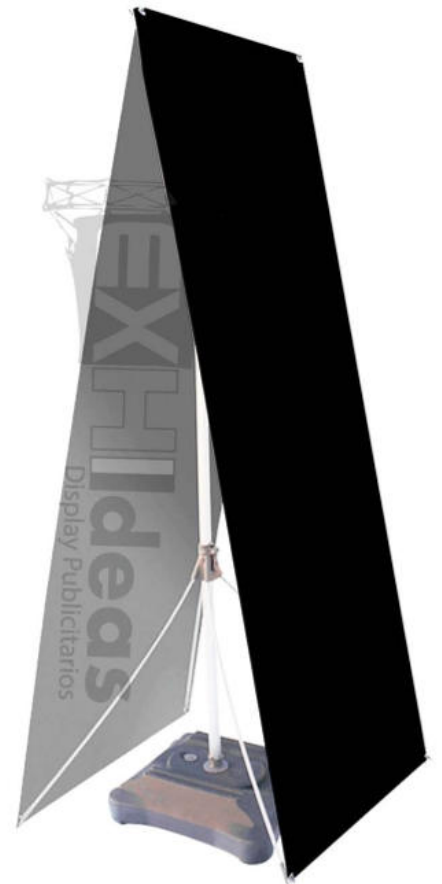

*Con bolsa de transporte incluida





MOCHILA BANNER

Código: MOCH

Mochila X-Banner reforzada
Con soportes para botellas de agua
Tamaño de mochila: 61cm * 47cm
Tamaño de banner: 60cm * 110cm



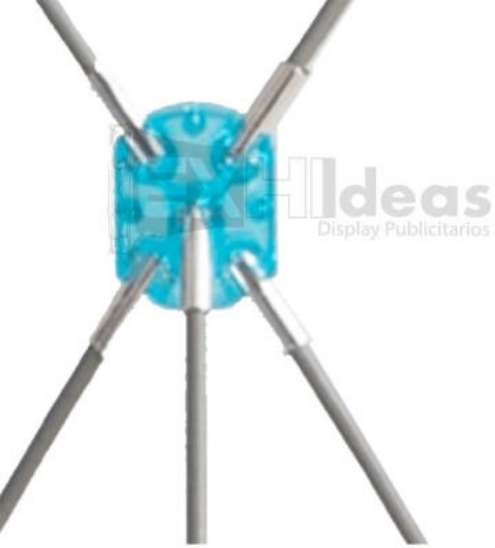

EXH Ideas
Display Publicitarios



MINI X-BANNER A3

Código: X-B A3

Mini X-Banner
Tamaño A3 (30cm * 42cm)
Hecho de aluminio y fibra de vidrio

Peso: .30kg

MINI X-BANNER A4

Código: X-B A4

Mini X-Banner
Tamaño A4 (21cm * 30cm)
Hecho de aluminio y fibra de vidrio

Peso: .30kg



*A4



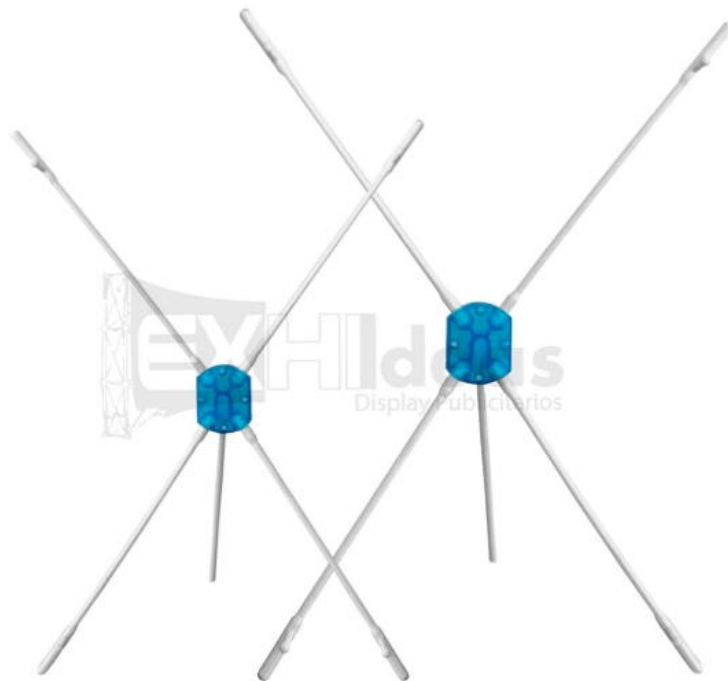

MINI X-BANNER ECONÓMICO

Código: X-B A3 ECO

Estructura ligeras de plástico
medida: A3

MINI X-BANNER ECONÓMICO

Código: X-B A4 ECO

Estructura ligera de plástico
medida: A4





BANNER GOLF

Código: BA-GOLF

Banner especial para tela sublimada
Cuenta con guías perimetrales para
el armado y costura
Incluye 4 estacas
Especial para exteriores

Peso: 3kg

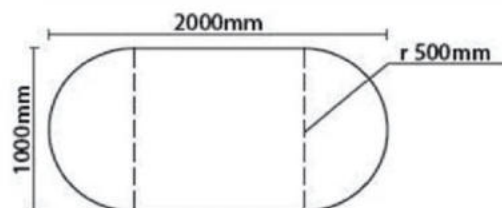
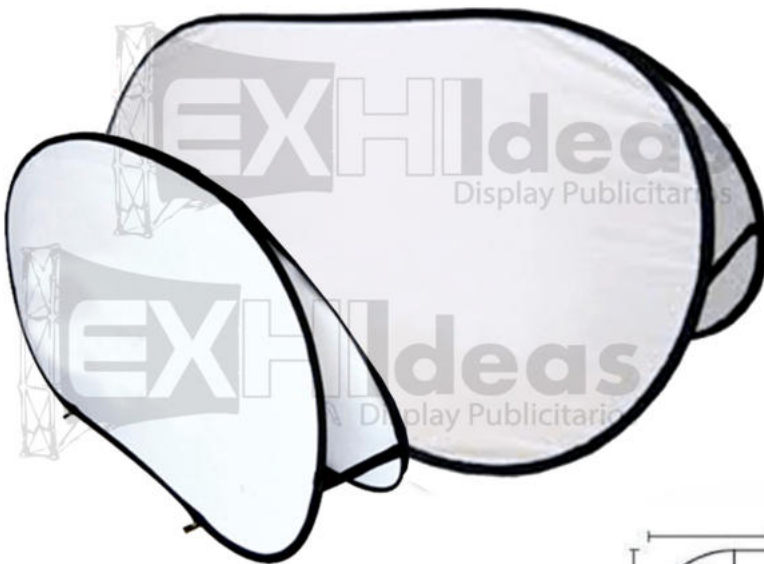

*Medidas



*Estacas



EXH Ideas

Display Publicitarios

FLYING BANNER

Para exteriores

Soporte publicitario en forma de bandera Especial para tela sublimada, este puede tomar forma de pluma o gota Hecho de aluminio, metal y fibra de vidrio Resistente y elegante Ideal para exteriores, debido a su base que se mueve de manera libre evitando que el aire lo derribe



BANNER FLYING S

Código: FLYING-S

Bandera banner premium

Medida: 3.5m

Base de metal, estructura de aluminio

Varas flexibles que le dan forma

a la bandera

Peso: 5kg

BANNER FLYING M

Código: FLYING-M

Bandera banner premium

Medida: 4.5m

Base de metal, estructura de aluminio

Varas flexibles que le dan forma

a la bandera

Peso: 5kg

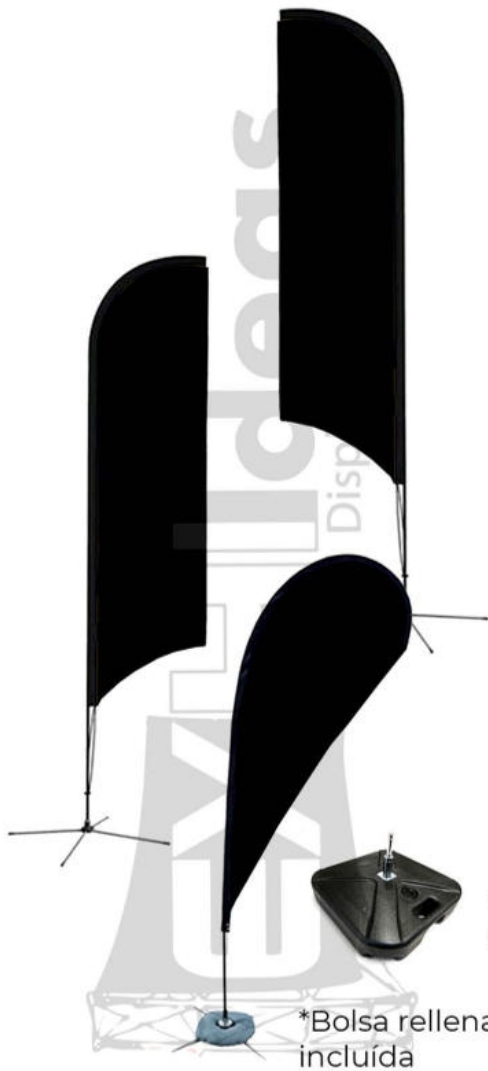

*Base rellenable
se vende por separado

*Bolsa rellenable
incluida

BANNER FLYING

Código: FLYING

Bandera banner premium

Medida: 5.9m

Base de metal, estructura de aluminio

Varas flexibles que le dan forma

a la bandera

Peso: 5kg

Maleta de transporte
incluida*





BANNER FLYING S ESTACA

Código: FLYING-S

Bandera banner premium

Medida: 3.5m

Estaca de metal, estructura de aluminio

Varas flexibles que le dan forma a la bandera

Peso: 5kg

BANNER FLYING M ESTACA

Código: FLYING-M

Bandera banner premium

Medida: 4.5m

Estaca de metal, estructura de aluminio

Varas flexibles que le dan forma a la bandera

Peso: 5kg

BANNER FLYING ESTACA

Código: FLYING

Bandera banner premium

Medida: 5.9m

Estaca de metal, estructura de aluminio

Varas flexibles que le dan forma a la bandera

Peso: 5kg

Maleta de transporte
incluída*

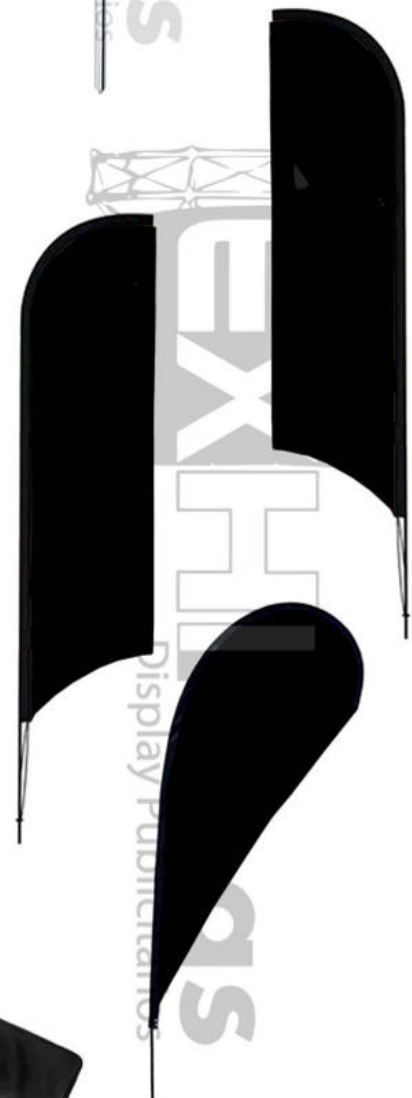

Display Publicitarios

BANNER FLYING S ECONÓMICO

Código: ECO BANDERA IMP-S

Bandera banner económica de línea

Medida: 3.4m

Estaca de metal, estructura de aluminio

Varas flexibles que le dan forma a la bandera

Peso: 3kg

BANNER FLYING M ECONÓMICO

Código: ECO BANDERA IMP-M

Bandera banner económica de línea

Medida: 4.5m

Estaca de metal, estructura de aluminio

Varas flexibles que le dan forma a la bandera

Peso: 3kg



Maleta de transporte incluida*



*Base rellenable se vende por separado

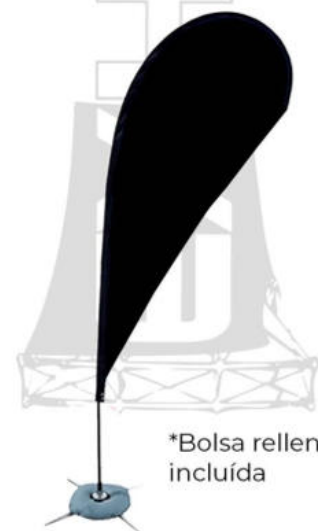

*Bolsa rellenable incluida





BANDERA RECTA 5M

Código: FLYING BANNER RECTA 5M

Estructura tipo bandera de aluminio telescópica, con base rellenable plástica Especial para exteriores

Medida: 5 metros
Medida del gráfico:
123cm de largo * 400cm de alto

Peso estructura: 10.2 kg
Peso base rellena de agua: 60kg





MINI BANDERA ESCRITORIO

Código: MINI FLYING

Mini bandera banner para escritorio

Medida: 15cm * 30cm

Base de aluminio y varilla fibra de vidrio

Peso: 0.17kg

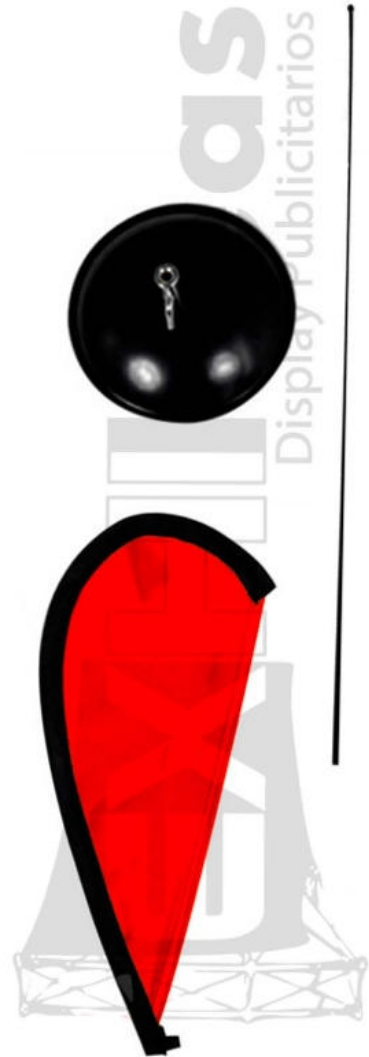



MOCHILA BANDERA

Código: MOCHILA BANDERA

Mochila reforzada ligera
Cuenta con soportes para botellas de agua
y almacenamiento de catálogos
Medida del gráfico: 43cm * 125cm
Especial para tela sublimada

Peso: 1.6kg



DEMO STAND

Para interiores/exteriores

Estructura publicitaria que facilita la exposición de productos y la atención al cliente

Material de PVC o MDF

Es portátil y sirve para cualquier evento (ferias, exposiciones, muestras de producto promociones , etc)





DEMO STAND PVC

Código: PT-1

Demo stand de PVC recto
Mesa de muestreo amplia
Copete montable
Especial para rotulación
Medida: 200cm * 83cm

Peso: 8kg



*Maleta de transporte
incluida

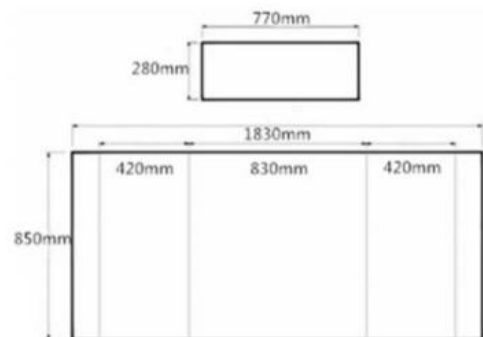



*Maleta de transporte
incluida



DEMO STAND ECONÓMICO

Código: PT-1 ECO

Estructura de PVC económico recto
Mesa de muestreo amplia
Copete montable
Especial para rotulación
Medida: 200cm*80cm

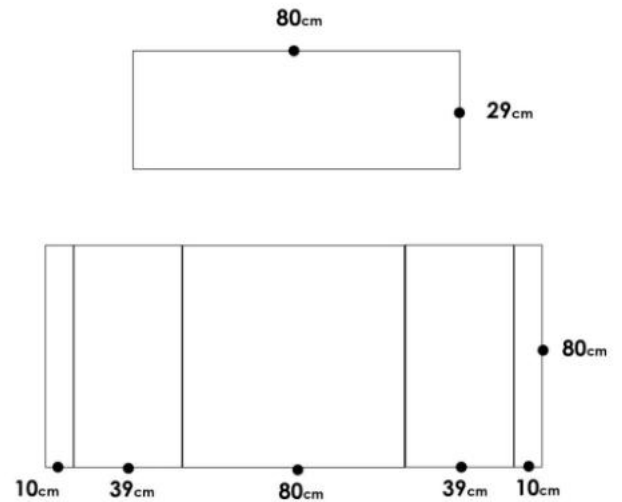

DEMO STAND PVC

Código: PT-2

Demo stand de PVC curvo
Mesa de muestreo amplia
Copete montable
Especial para rotulación
Medida: 200cm * 123cm

Peso: 8kg

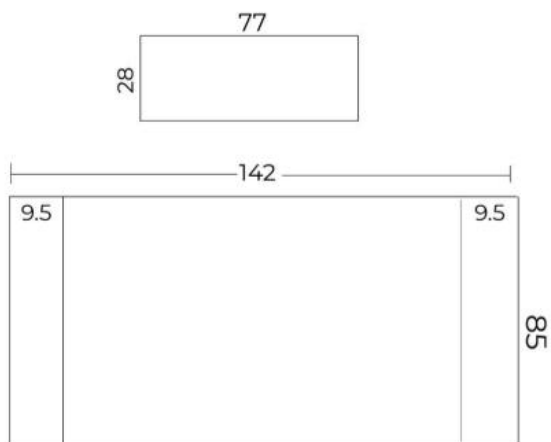

*Maleta de transporte
incluída





DEMO STAND MDF

Código: PT-3

Demo stand estructura de aluminio
Copete montable
Repisas de MDF
Diseño sencillo
Medidas: 200cm * 83cm

Peso: 11kg



*Maleta de transporte
incluida

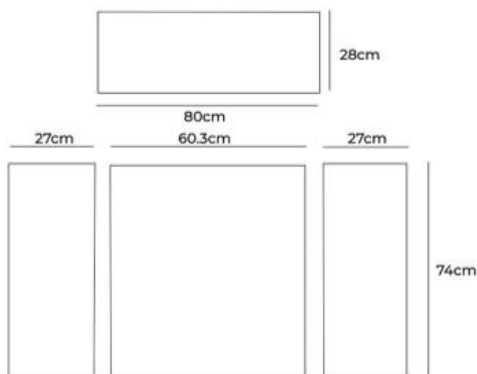



*Maleta de transporte
incluída



DEMO STAND MDF

Código: PT-4

Demo stand estructura de aluminio
Repisas de MDF
Copete montable
Diseño con puertas, cerradura
(llaves incluídas) y ruedas
Medidas: 200cm * 83cm

Peso: 11kg

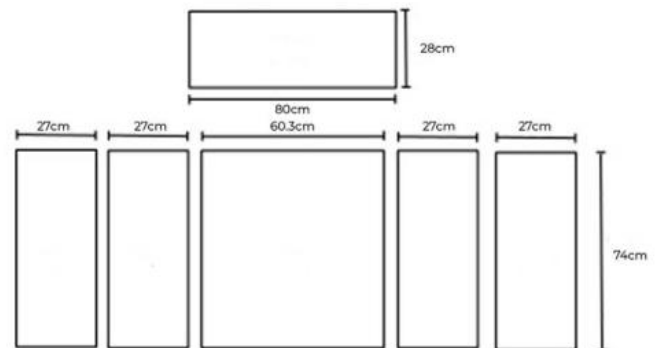



*Maleta de transporte
incluída

DEMO STAND PVC DELUX

Código: PT-5

Demo stand de PVC reforzado recto
Mesa de muestreo más amplia
Copete montable
Especial para rotulación
Medida: 200cm*83cm

Peso: 8kg

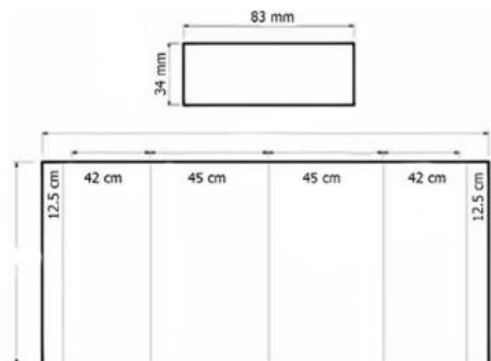



DEMO POP UP

Código: POP UP

Demo stand estructura de aluminio
Repisa de MDF especial para tela sublimada
Medida de gráfico: 200cm * 95cm

Peso: 12.8kg



*Maleta de transporte
incluida





DEMO POP UP TUBULAR

Código: POP UP TUBE

Demo stand tubular estructura de aluminio
Repisa de MDF especial para tela sublimada
Medida de gráfico: 233cm * 102cm
Medida de altura: 97cm
Medida de mesa: 80cm * 40cm
Incluye cierre y silicón perimetral para adherir al gráfico

Peso: 5kg



*Maleta de transporte incluida



MURO O PARED PUBLICITARIO

Para exteriores/Interiores

Estructuras de aluminio ligeras y resistentes que permiten exhibir gráficos de gran formato, especiales para tela sublimada





MURO AJUSTABLE

Código: V-POP AJUSTABLE

Marco de aluminio grueso

Medidas ajustables: 2.27m * 2.27m / 2.27m * 3.06m

Estructura de vista doble

Placas de acero

Tanques rellenables (cada tanque lleno aumenta 20kg de peso soporte)

Peso: 18kg



*Maleta de transporte se vende por separado





MURO TUBULAR RECTO

Código: TUBE R

Estructura tubular recta
Hecho de aluminio ensamblable
que moldea el gráfico de tela sublimada
Estructura de doble vista
Medida: 2.29m * 2.92m

Peso: 13kg

MURO TUBULAR RECTO

Código: TUBE R-6M

Estructura tubular recta
Hecho de aluminio ensamblable
que moldea el gráfico de tela sublimada
Estructura de doble vista
Medida: 5.9m * 2.29m

Peso: 18kg

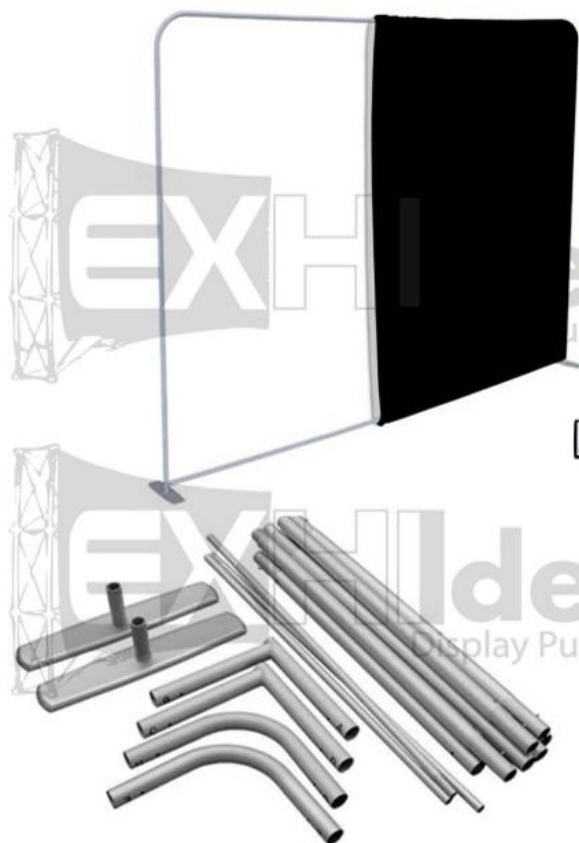

*Incluye Zipper para gráfico



*Lámparas
halógenas se venden por separado



*Maleta de transporte
incluída

MURO TUBULAR CURVO

Código: TUBE C

Estructura ensamblable tubular
Hecho de aluminio que moldea
el gráfico de tela sublimada
Estructura de doble vista
Medida: 2.30m * 3.07m

Peso: 5.5kg



MURO TUBULAR CURVO

Código: TUBE C 6M

Estructura ensamblable tubular
Hecho de aluminio que moldea
el gráfico de tela sublimada
Estructura de doble vista
Medida: 2.30m * 5.90m

Peso: 6kg

*Maleta de transporte
incluída



Incluye Zipper para gráfico*



*Lámparas halógenas
se venden por separado

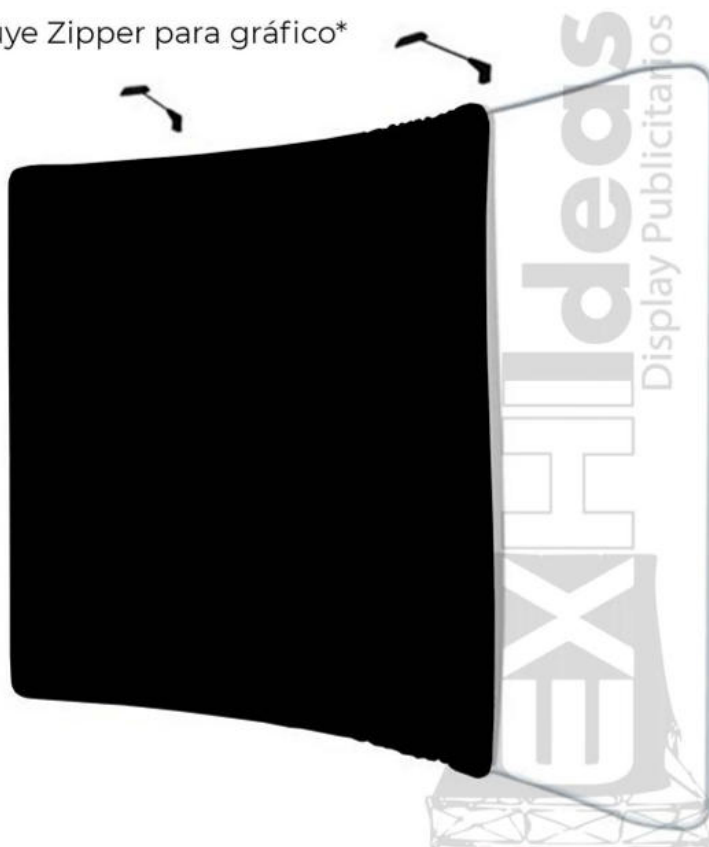



MURO FOTOGRÁFICO 4x3

Código: V-POP FOTOGRAFICO 4X3

Valla o Muro tubular de aluminio expandible tipo fotográfico
Especial para tela impresa
Se puede utilizar como fondo para efectos especiales
(agregandole tela verde o azul)

Medidas desde: 2.27m * 3.06m
hasta: 1.20m * 1.54m

Peso: 6.8kg



*Maleta de transporte
incluída

Tela se vende
por separado*





MURO FOTOGRÁFICO

Código: V-POP FOTOGRAFICO

Valla o Muro tubular de aluminio expandible tipo fotografico
Especial para tela impresa
Se puede utilizar como fondo para efectos especiales
(agregandole tela verde o azul)
Medidas: desde 2.27m * 2.27m
hasta 94cm * 1.54m

Peso: 6kg



*Maleta de transporte
incluida

Tela se vende
por separado*





MURO EXPANDIBLE

Código: V-POP 3X3

Estructura hecho de aluminio alta calidad
Perímetro con velcro para adherir el gráfico
Medida: 2.27m * 2.27m

Peso: 14kg



*Maleta de transporte
incluída

MURO EXPANDIBLE

Código: V-POP 3X4

Estructura hecho de aluminio alta calidad
Perímetro con velcro para adherir el gráfico
Medida: 3.06m * 2.27m

Peso: 16kg

MURO EXPANDIBLE

Código: V-POP 4X5

Estructura hecho de aluminio alta calidad
Perímetro con velcro para adherir el gráfico
Medida: 3.06m * 3.82m

Peso: 17kg

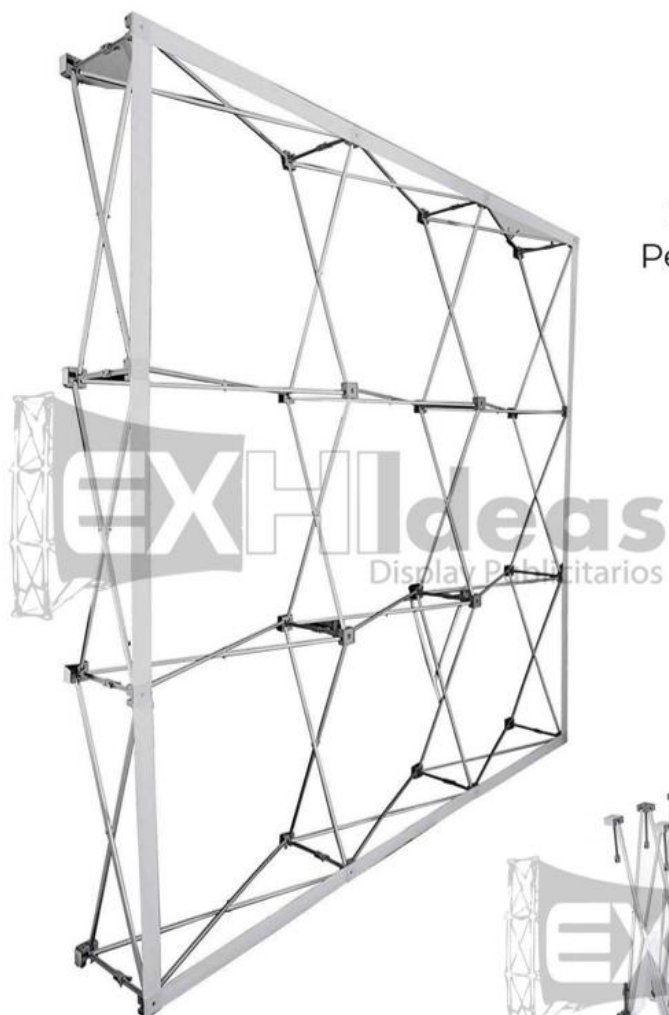

*Lámparas
halógenas no incluídas



*Velcro





MURO EXPANDIBLE

Código: BB-CURVE 3X3M

Estructura curva
Hecho de aluminio de alta calidad
Perímetro con velcro para adherir el gráfico
Medidas: 2.27m * 2.27m

Peso: 14kg



*Velcro

MURO EXPANDIBLE

Código: BB-CURVE 3X4M

Estructura curva
Hecho de aluminio de alta calidad
Perímetro con velcro para adherir el gráfico
Medidas: 2.27m * 3.06m

Peso: 16kg



*Maleta de transporte
incluida



*Lámparas
halógenas no incluidas





REVISTEROS Para interiores

Estructuras especiales para la exposición de volantes promocionales, catálogos, revistas e incluso material electrónico



*Maleta de transporte
incluída



REVISTERO SENCILLO

Código: PCS-SINGL

Estructura tubular de aluminio ensamblable

4 Bolsillos de tela nylon

Medida de bolsillos: 21cm * 30cm

Medidas: 139cm altura / 30cm ancho

Peso: 1.3kg

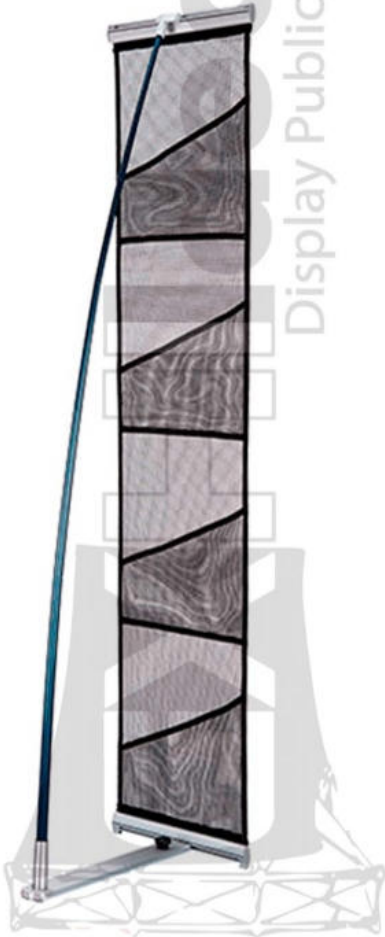



REVISTERO DOBLE

Código: PCS-DOUBLE

Estructura tubular de aluminio ensamblable

8 Bolsillos de tela nylon

Medida de bolsillos: 21cm * 30cm

Medidas: 139cm altura / 54.5cm ancho

Peso: 1.7kg

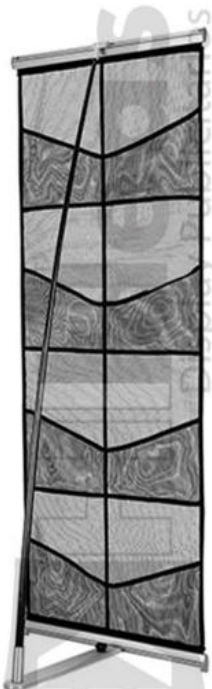

*Maleta de transporte
incluida





REVISTERO DE ACRÍLICO

Código: REV-ALU

Estructura elegante plegable en forma de Z
Marco cromado de acero y aluminio
7 paneles de acrílico
Medidas de paneles: 21cm * 30cm
Proporcionan acceso por los dos lados

Peso: 5.2kg



*Maleta de transporte
incluida

EXH Ideas
Display Publicitarios

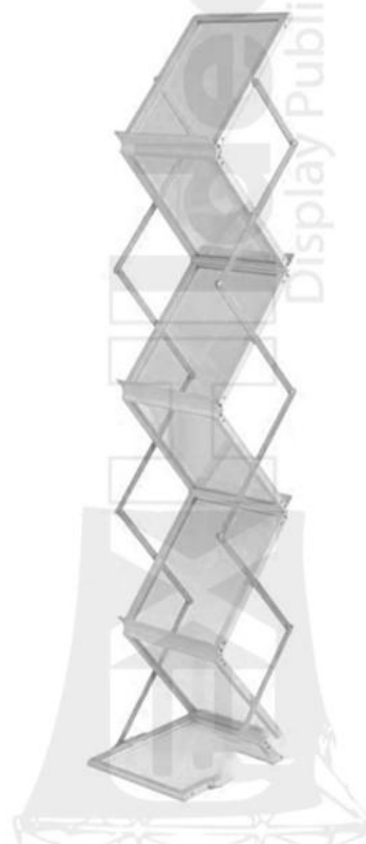



REVISTERO TUBULAR

Código: RV-TELA

Estructura tubular de aluminio ensamblable

Para forrar con tela sublimada

2 rejillas metálicas

Medida de altura: 133cm

Medidas: 181cm alto / 45cm ancho

Peso: 5kg

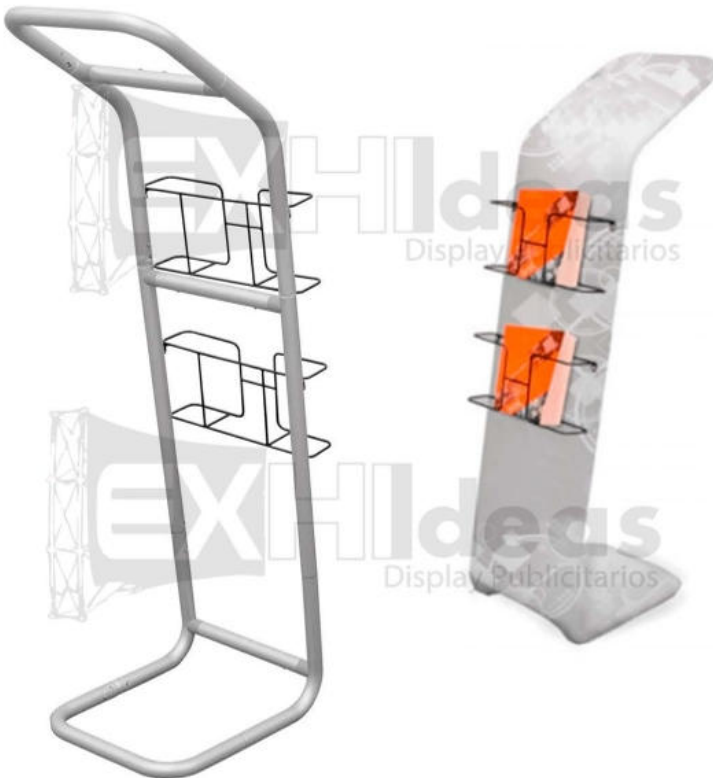

*Maleta de transporte
incluída



TORRE TWISTER

Código: TOWER T2A

Estructura retráctil de aluminio
Bases media luna de PVC diámetro 45 cm
Medida de altura: 192cm
Estructura con luz led

Peso: 10kg



*Maleta de transporte
incluida





ISLA TUBULAR CON REPISA

Código: ISLA-TELA

Estructura ensamblable tubular de aluminio

Ideales para tela sublimada

Estructura doble vista

Entrepañó de acrílico, base de MDF

Medida de altura: 204cm

Medida *Ancho 1: 85cm

Medida *Ancho 2: 59cm

Peso: 5.5kg

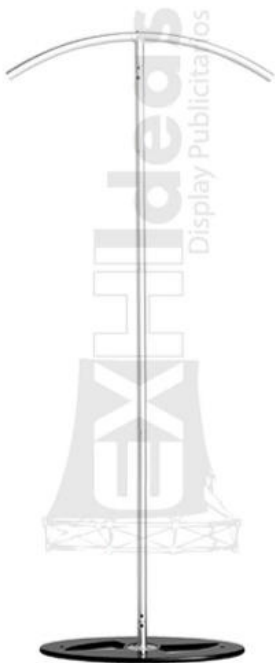

*Lámpara se vende por separado



*Ancho 1

*Ancho 2



*Maleta de transporte
incluída





TOLDOS

Exteriores/Interiores

Estructura plegable

Hecho de acero calibre 18 (1,21 mm)

Conectores de plástico y pies de acero

Puede llevar tela impermeable lisa o sublimada



Maleta
de transporte
se vende
por separado*



*Tela impermeable
se vende por separado
Resistente al sol y lluvia
Se puede lavar y sublimar
Colores disponibles:
Azul
Blanco
Rojo



TOLDO 2X2M

Código: tent

Estructura plegable
Hecho de acero calibre 18
Conectores plásticos y pies de acero
Práctico y muy resistente al viento
Abarca el espacio de 2 metros cuadrados

Peso: 16kg





TOLDO 3X3M

Código: TENT 3MX3

Estructura plegable
Hecho de acero calibre 18
Conectores plásticos y pies de acero
Práctico y resistente al viento
Abarca el espacio de 3 metros cuadrados

Peso: 20kg



*Maleta de transporte se vende por separado



*Tela impermeable se vende por separado
Resistente al sol y lluvia
Se puede lavar y sublimar
Colores disponibles:
Azul
Blanco
Rojo





*Tela impermeable
se vende por separado
Resistente al sol y lluvia
Se puede lavar y sublimar
Colores disponibles:
Azul
Blanco
Rojo



TOLDO 3X6M

Código: TENT 3MX6

Estructura plegable
Hecho de acero calibre 18
Conectores plásticos y pies de acero
Práctico y resistente al viento
Abarca el espacio de 3 * 6 metros cuadrados

Peso: 35kg



*Maleta
de transporte
se vende
por separado



EXHIdeas
Display Publicitarios

*Incluye una pestaña



EXHIdeas
Display Publicitarios

*Tela se vende por separado



TOLDO COPULA 3X3

Código: TOL 3X3 CUPULA

Estructura ensamblable pentagonal

Hecho de aluminio

Resistente al viento

Altura de entradas: 2.2 m

Altura total: 5 m

Peso: 28kg



EXHIdeas
Display Publicitarios



*Incluye una
pestaña



*Tela se vende por
separado



TOLDO COPULA 4.5 X 4.5

Código: TENT 4.5X4.5 CUPULA

Estructura ensamblable pentagonal

Hecho de aluminio

Resistente al viento

Altura de entradas: 2.2 m

Altura total: 7.5 m

Peso: 28kg





COLGANTES Interiores

Estructuras ensamblables de aluminio
Especiales para montar con tela, ligeras y elegantes

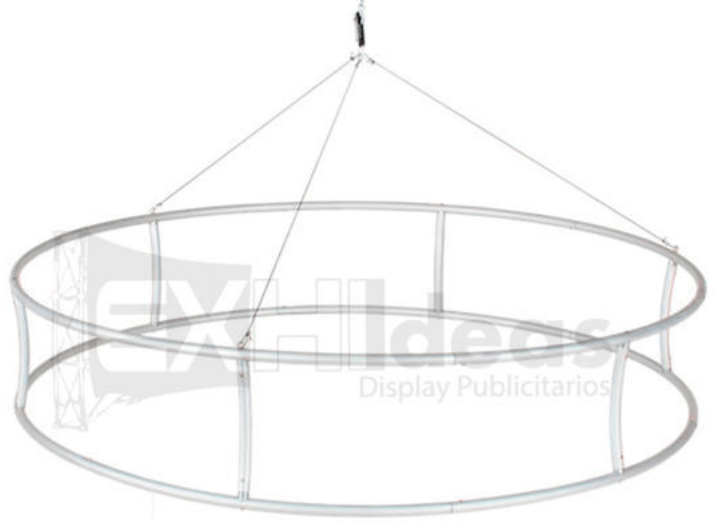

COLGANTE CIRCULAR

Código: COLGANTE-C

Estructura circular ensamblable
Hecho de aluminio
Para colgar en estructuras y techos
Especial para tela
Ideal para impresion doble vista
Incluye:

10.3 metros de alambre de acero, gancho y zipper para tela
Medidas: Diámetro 3m / Circunferencia 9.42m

Peso: 9.5kg



*Maleta de transporte
incluída

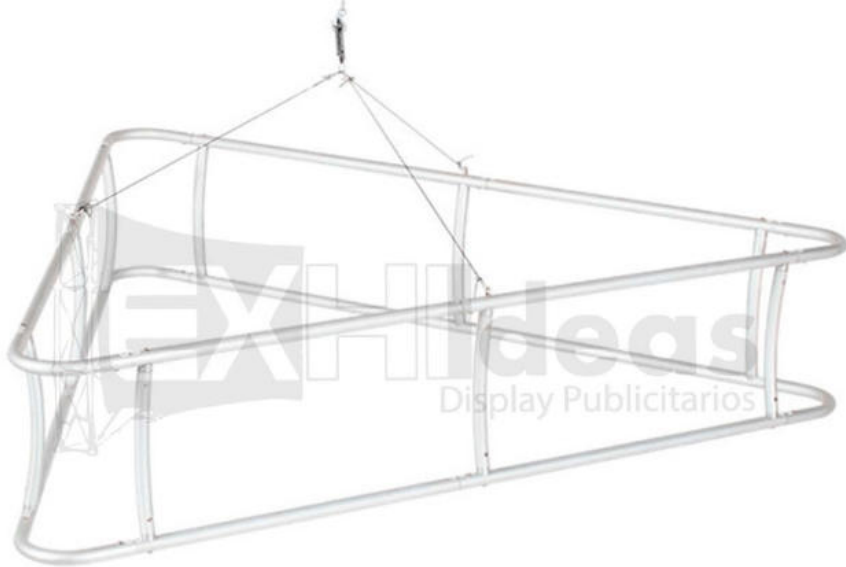

COLGANTE TRIANGULAR

Código: COLGANTE-T

Estructura triangular ensamblable
Hecho de aluminio
Para colgar en estructuras y techos
Especial para tela
Idea para impresion doble vista

Incluye:

10.3 metros de alambre de acero, gancho y zipper para tela
Medidas: 3m por lado / 1.07m de altura

Peso: 9.5kg



*Maleta de transporte
incluída





COLGANTE BANNER

Código: COLGANTE 60X90

Estructura tipo riel
Hecho de aluminio grueso
Colgantes plásticos
Medida: 60cm * 90cm

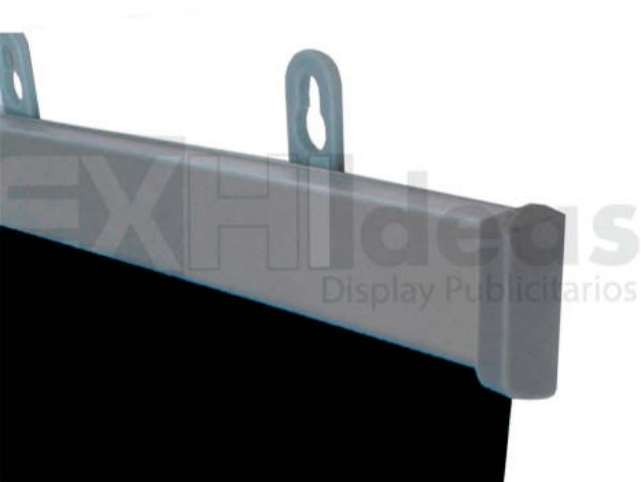
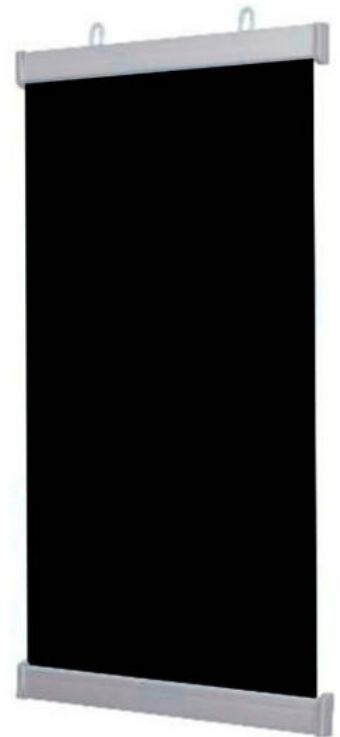

EXH Ideas
Display Publicitarios



STAND PACK

Interiores

Paquetes de stands, ideal para cualquier tipo de evento

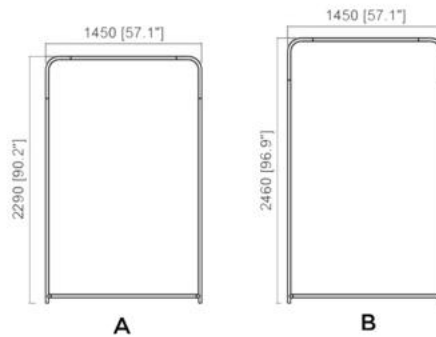
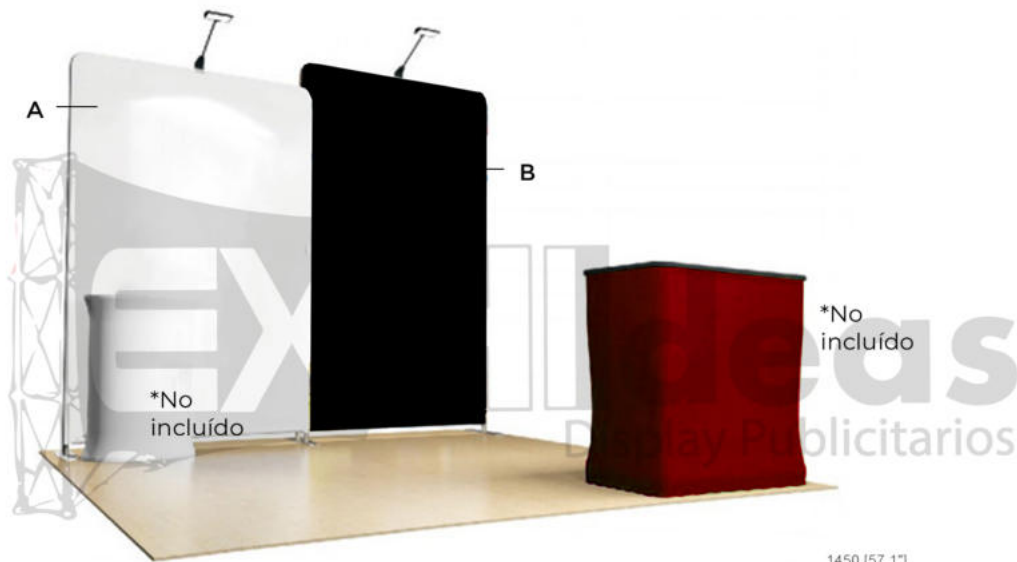

PAQUETE TUBULAR

Código: PACK 1001

El paquete consta de 2 paredes tubulares de aluminio

A: 1.45m * 2.29m & B: 1.45m * 2.46m

Especiales para tela, ideal para impresion doble visa

Incluye zipper para tela

Cubre el fondo de un stand de 3 metros



*Maleta de transporte
incluída



*Lámparas
halógenas se venden por separado

Peso: 9.5kg

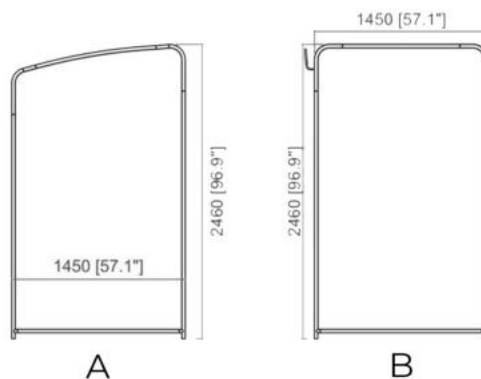

PAQUETE TUBULAR

Código: PACK 1002

El paquete consta de 2 paredes tubulares de aluminio

A: 1.45m * 2.46m & B: 1.45m * 2.46m

Especiales para tela, ideal para impresión doble vista

Incluye zipper para tela

Cubre el fondo de un stand de 3 metros

Peso: 9.5kg



*Lámparas
halógenas se venden por separado

*Maleta de transporte
incluida

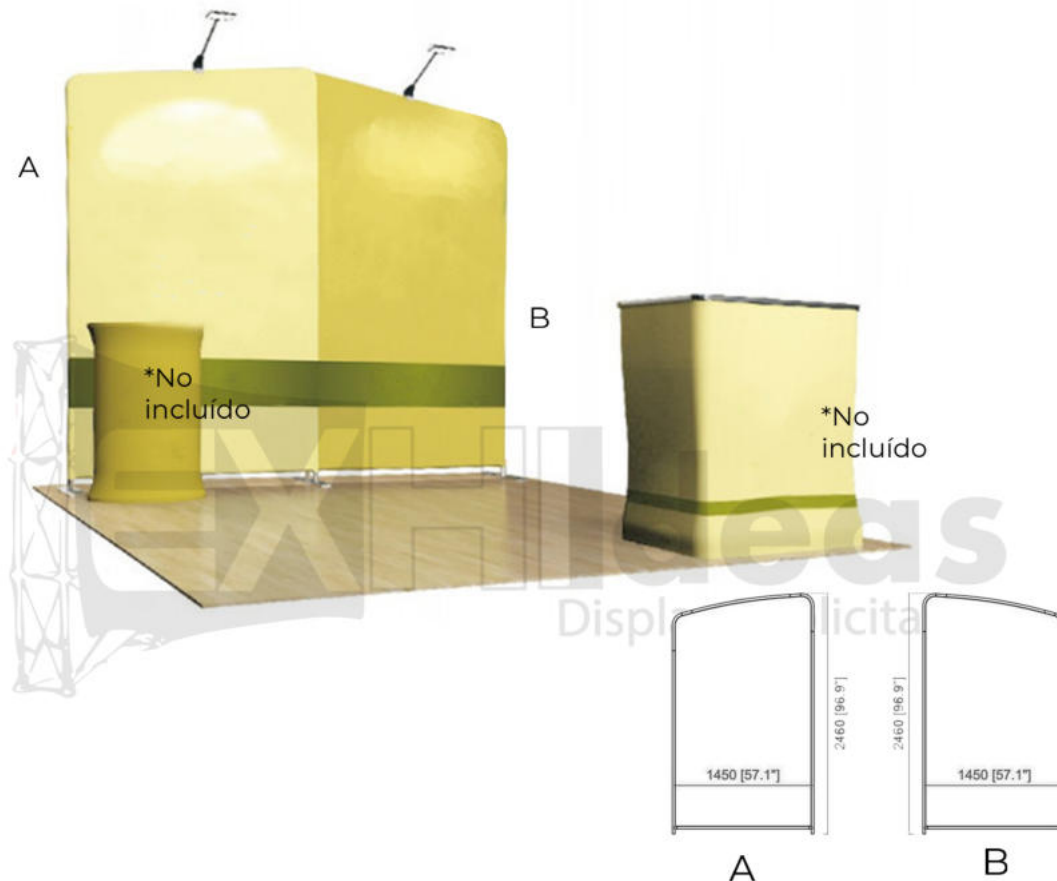

*Lámparas halógenas se venden por separado



PAQUETE TUBULAR

Código: PACK 1003

El paquete consta de 2 paredes tubulares de aluminio con inclinación

A: 1.45m * 2.46m & B: 1.45m * 2.46m

Especiales para tela, ideal para impresión doble vista

Incluye zipper para tela

Cubre el fondo de un stand de 3 metros

Peso: 9.5kg



*Maleta de transporte incluida

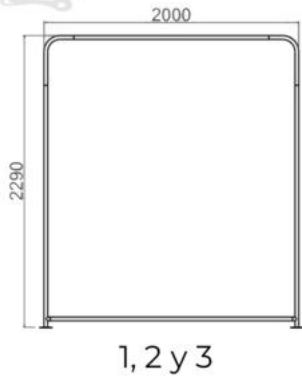

*Lámparas halógenas se venden por separado



PAQUETE TUBULAR

Código: PACK 2004

El paquete consta de 3 paredes tubulares de aluminio

1: 2m * 2.29m 2: 2m * 2.29m 3: 2m * 2.29m

Especial para tela, ideal para impresión doble vista

Incluye zipper para tela

Cubre el fondo de un stand de 6 metros

Peso: 14.5kg



*Maleta de transporte incluida

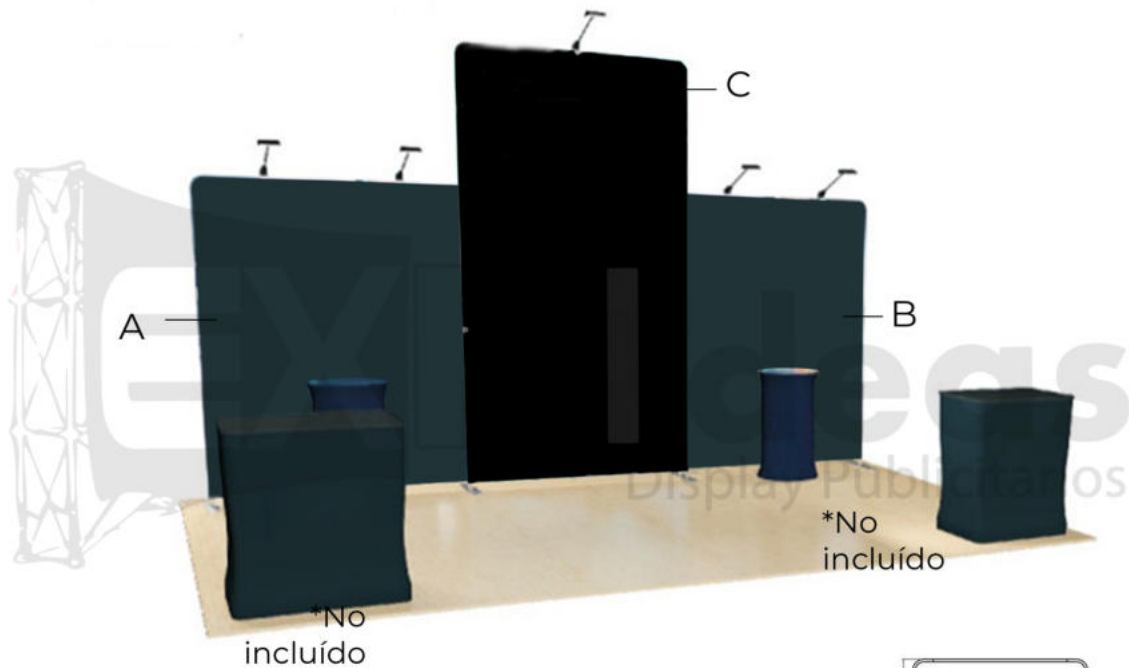

*Lámparas halógenas se venden por separado

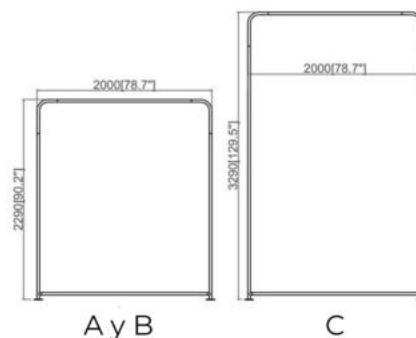

PAQUETE TUBULAR

Código: PACK 2008

El paquete consta de 3 paredes tubulares de aluminio
 A: 2m * 2.29m B: 2m * 2.29m C: 2m * 3.29m
 Especiales para tela, ideal para impresión doble vista
 Incluye zipper para tela
 Cubre el fondo de un stand de 6 metros



*Maleta de transporte incluida

Peso: 14.5kg

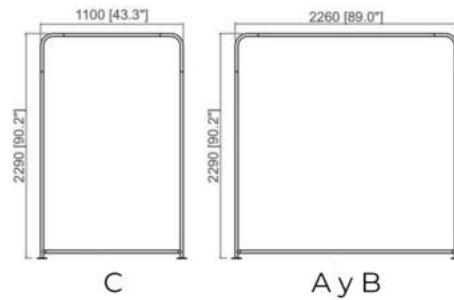
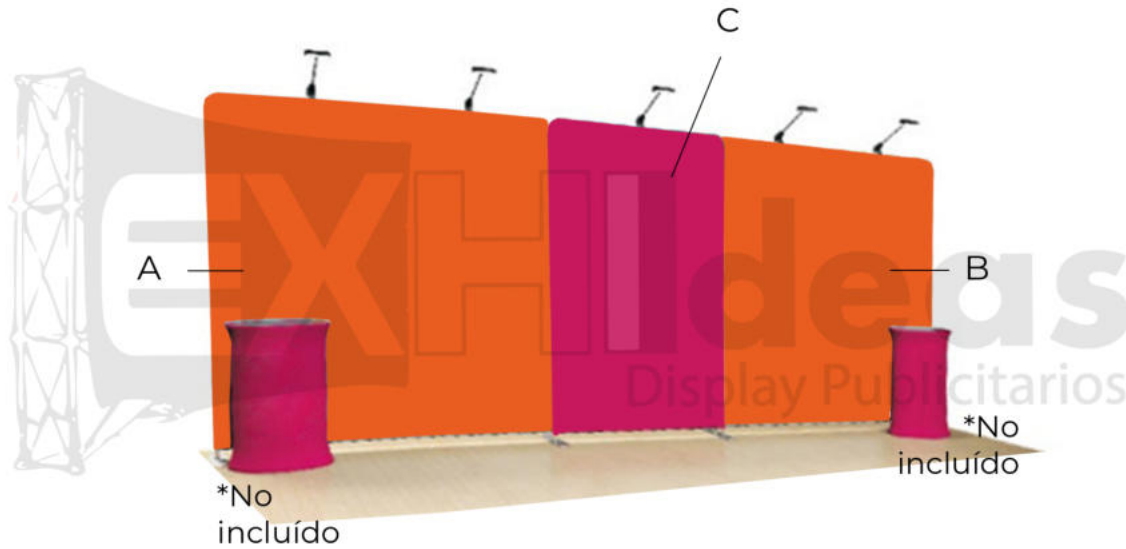

PAQUETE TUBULAR

Código: PACK 2002

El paquete consta de 3 paredes tubulares de aluminio

A: 2.26m * 2.29m B: 2.26m * 2.29m C: 1.10m * 2.29m

Especiales para tela, ideal para impresión doble vista

Incluye zipper para tela

Cubre el fondo de un stand de 6 metros

Peso: 14.5kg



*Lámparas halógenas se venden por separado



*Maleta de transporte incluida

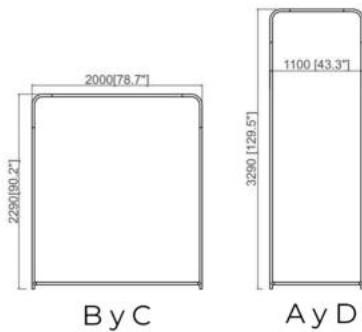
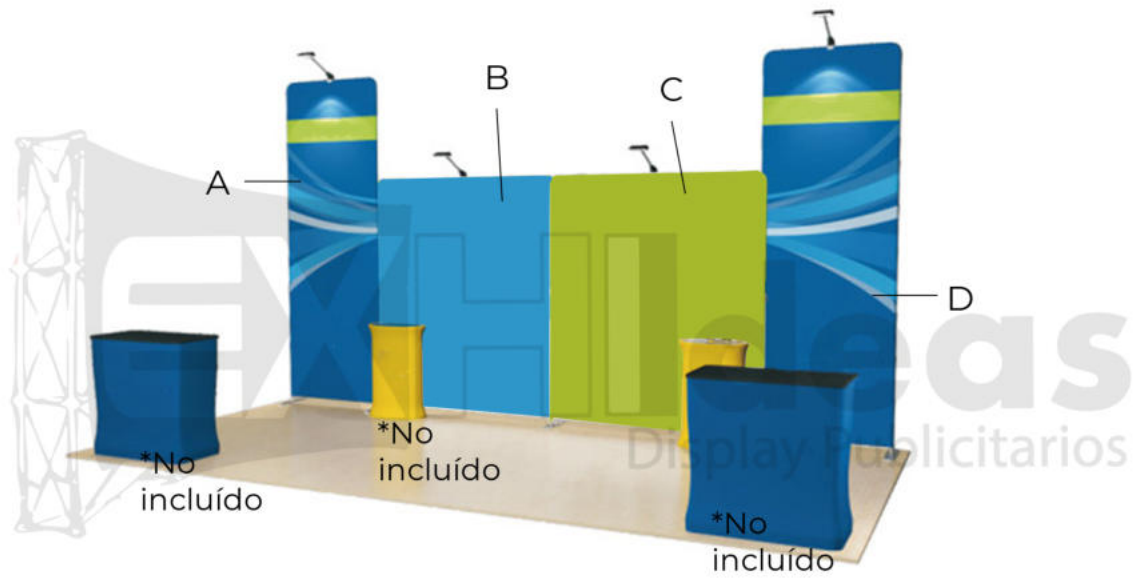

PAQUETE TUBULAR

Código: PACK 2012

El paquete consta de 4 paredes tubulares de aluminio
 A&D: 1.10m * 3.29m B&C: 2m * 2.29m
 Especiales para tela, ideal para impresión doble vista
 Incluye zipper para tela
 Cubre el fondo de un stand de 6 metros

Peso: 14.5kg



*Maleta de transporte
 incluida



*Lámparas
 halógenas se venden por separado



EXHIDEAS CUENTA CON REPUESTOS DE TODOS SUS PRODUCTOS

Facilitando el mantenimiento
de cualquiera de sus estructuras



SUCURSALES

Envíos a toda la república mexicana

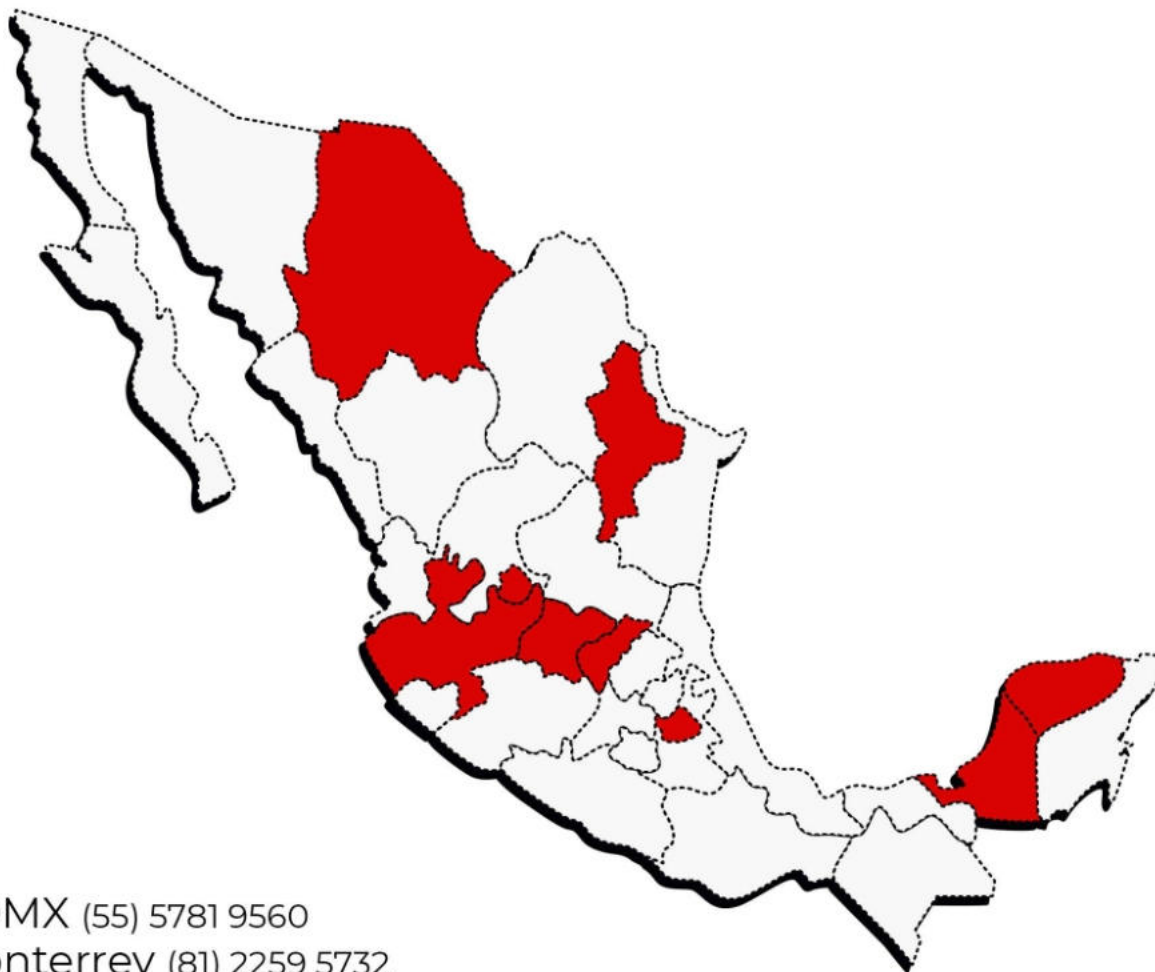

CDMX (55) 5781 9560
Monterrey (81) 2259 5732
Aguascalientes (44) 9140 1077
Chihuahua (61) 4411 2910
Campeche (98) 1164 6971
Mérida (99) 9926 2600
Guanajuato (47) 7784 0001
Querétaro (44) 2869 9115





Calle Vidrio 1625,
Americana, 44160 Guadalajara, Jal.

33 3803 1303
33 1891 0188