



EL DISPLAY PUBLICITARIO HA SIDO GRAN AYUDA EN EL MUNDO DE LA PUBLICIDAD Y EL ARTE DIGITAL

La promoción de una marca e incluso el arte digital se presenta de una manera fácil y eficaz gracias a la gran variedad de expositores que se manejan en el mercado.

En **Exhideas**, ofrecemos los expositores más innovadores y completos, adaptándose a las necesidades de nuestros clientes.

Ayudando a que la comunicación entre marca/receptor sea exitosa.

Los exhibidores pueden tener uso en diferentes áreas:
Eventos, Puntos de ventas, Promotoras, etc.





ROLL UP
#1-8



X-BANNER
#9-19



FLYING BANNER
#20-26



DEMO STAND
#27-35



MURO/PARED
#36-41



REVISTEROS
#42-47



TOLDOS
#48-53



COLGANTES
#54-57



STAND PACK
#58-65



Roll Up



Ideas

Display Publicitarios

ROLL UP

Especial para interiores

Se destaca por su fácil instalación es autoenrollable, hecho de aluminio ligero, el gráfico se adhiere por la parte inferior y una pinza lo sujeta por la parte superior.



ROLL UP 85*200

Código: RU-85

Roll up sencillo
mide 85cm * 200cm
se puede montar en tela, lona
o papel fotográfico

Peso: 2.3kg

ROLL UP DOBLE
Código: RU- 85 D

Roll up doble vista, se le puede adherir dos gráficos.
Mide 85cm * 200cm

Peso: 5.5kg

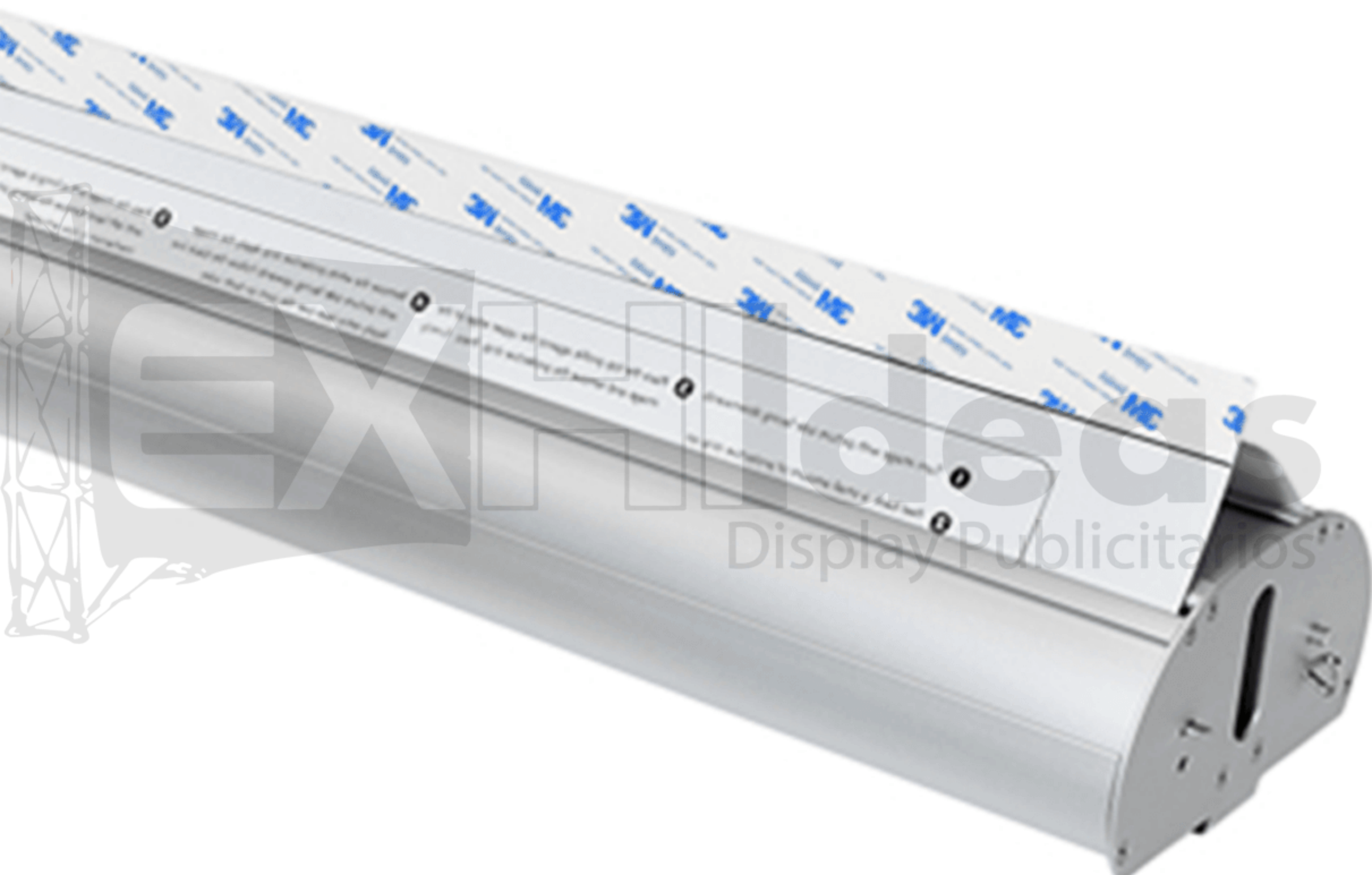
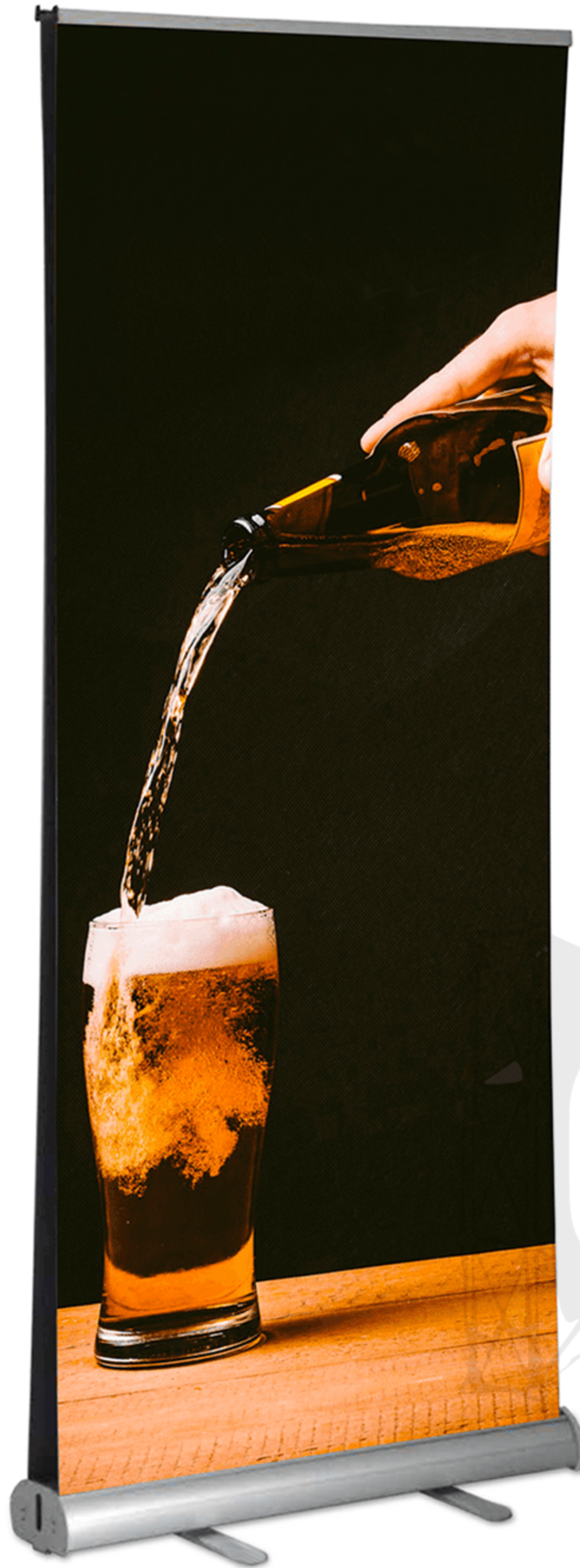

*Maleta incluida



ROLL UP 120*200

Código: RU-120

Roll up mediano
medida de 120cm * 200cm

Peso: 3.4kg



*Maleta incluida

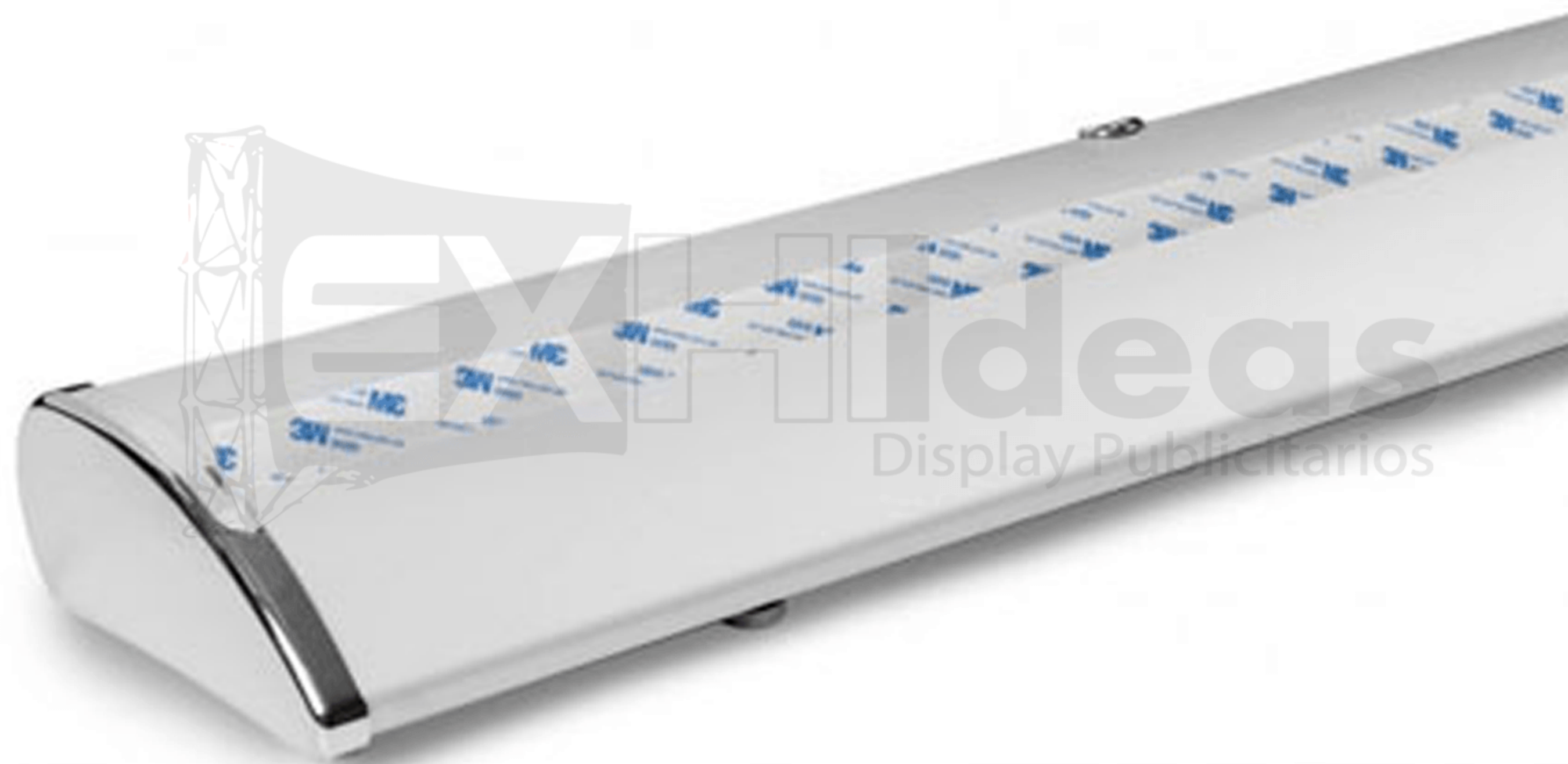

ROLL UP 200

Código: RU-200

Roll up grande
medida de 200cm * 200cm
se puede utilizar como
muro publicitario

Peso: 7.5kg



*Maleta incluida

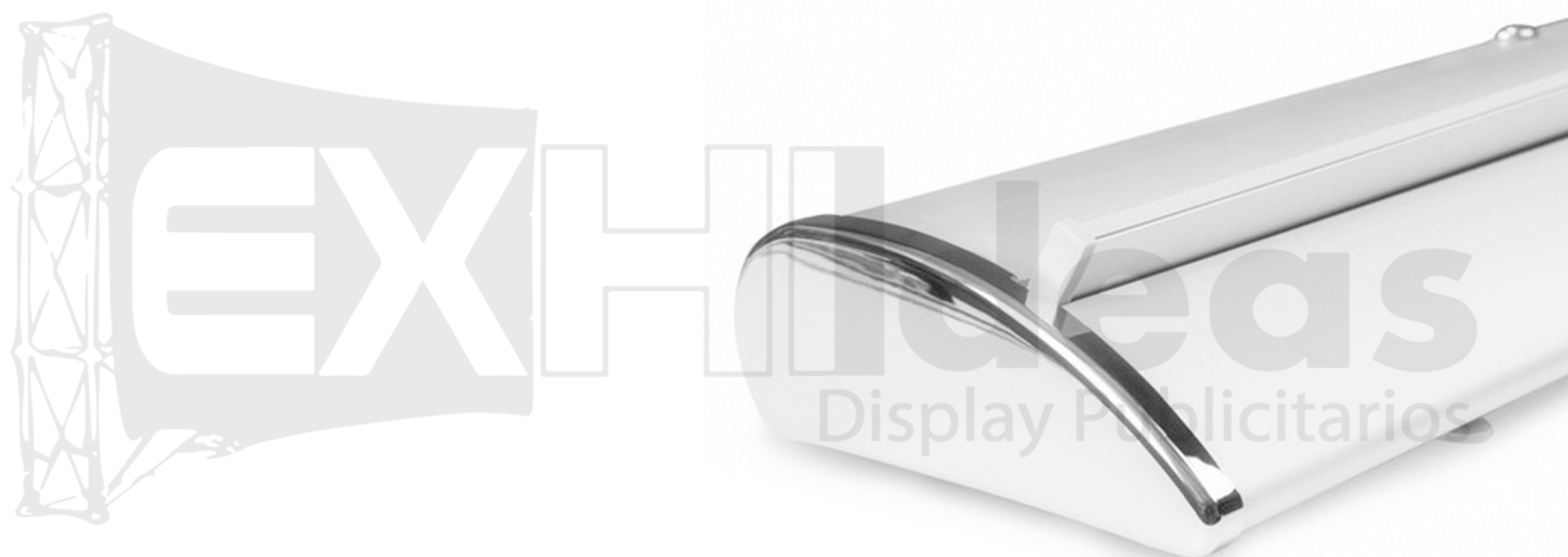
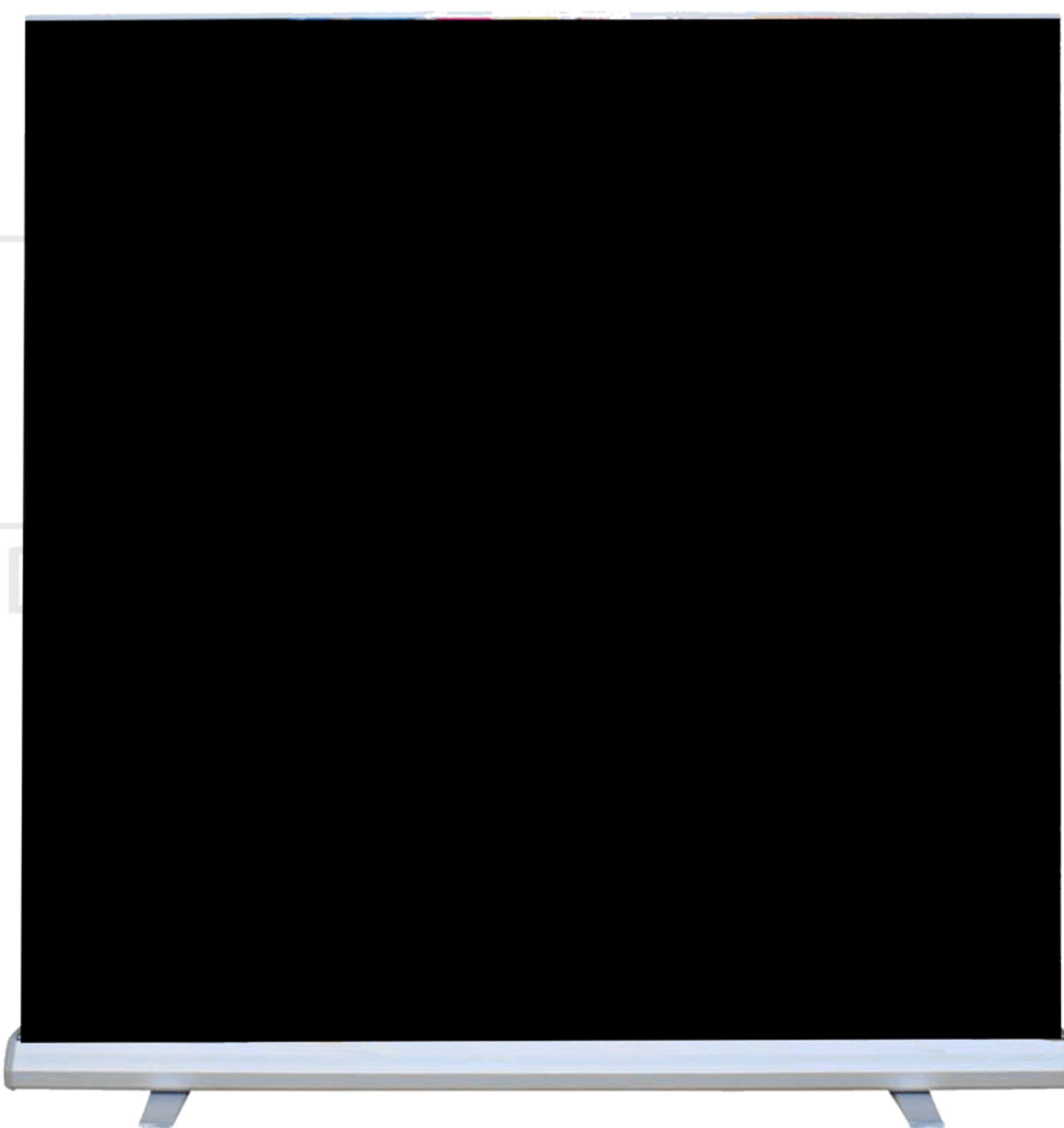



ROLL UP 240

Código: RU-240

Roll up muy grande
medida de 240cm * 200cm
se puede utilizar como muro
publicitario

Peso: 8.9kg



*Maleta incluida

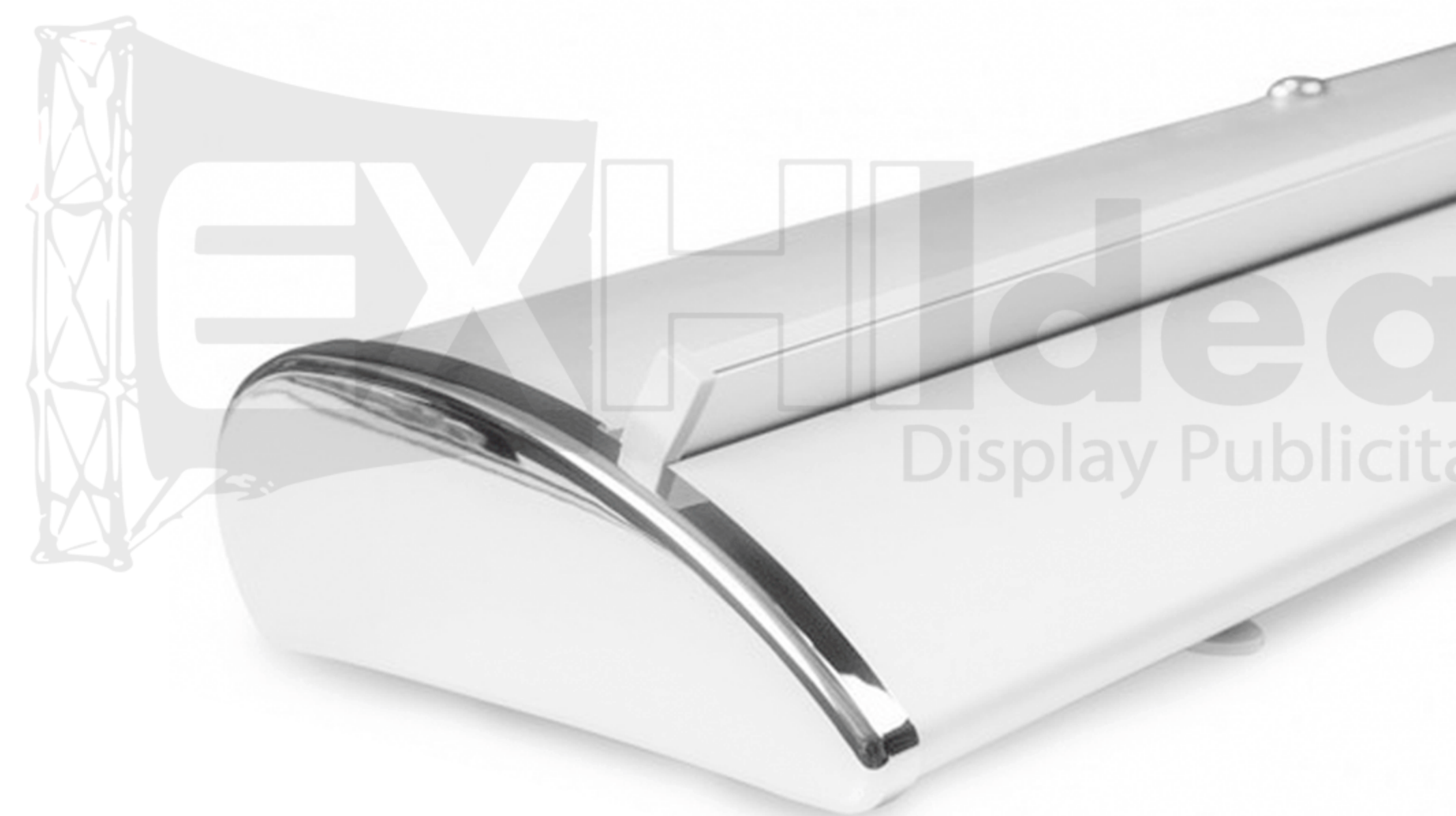

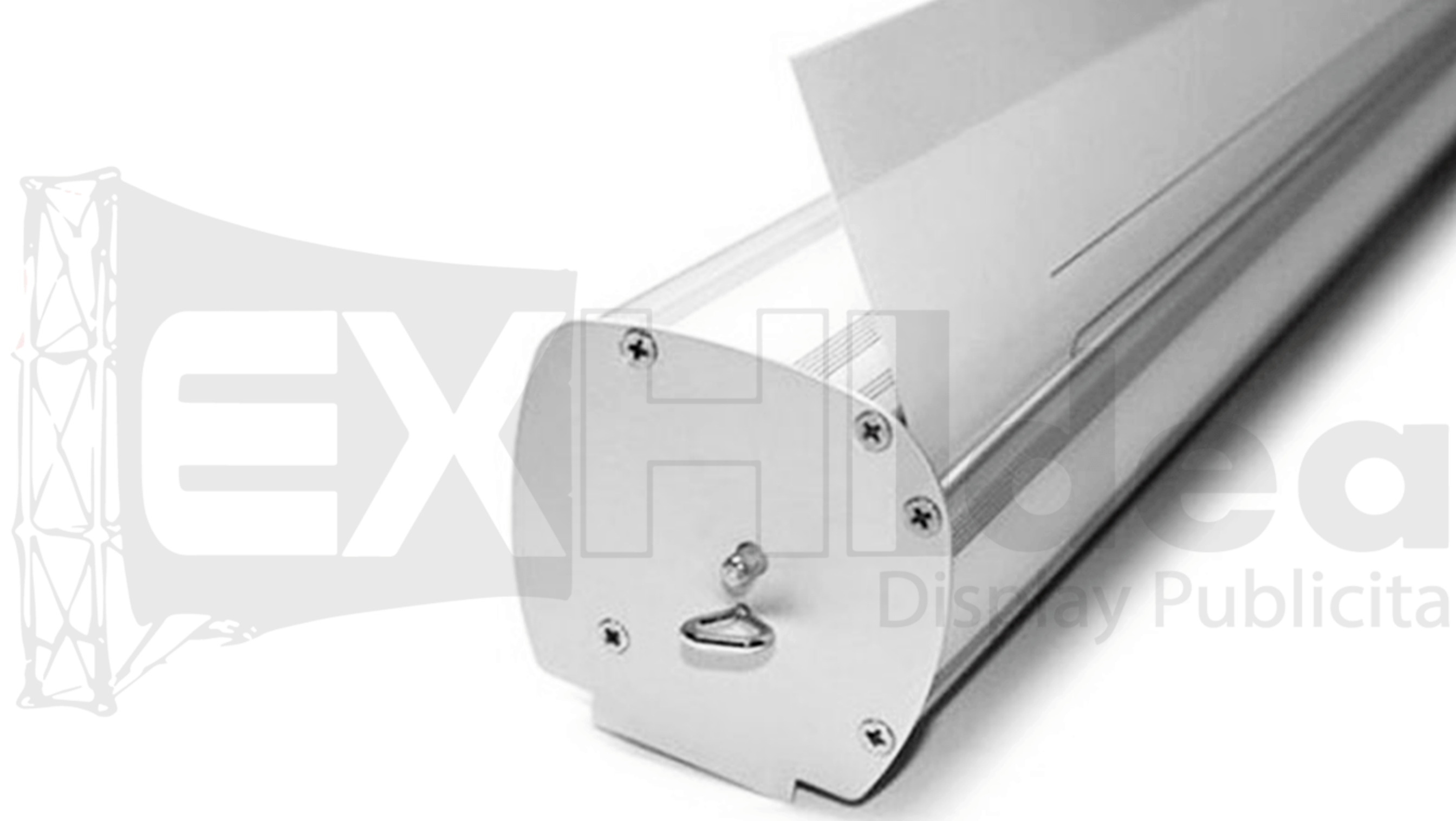

ROLL UP ECONÓMICO

Código: RU80-ECO

Roll up económico
medida de 80cm * 200
especial para interiores

Peso: 2kg



*Maleta incluida

MINI ROLL UP A4

Código: RU- M

Roll up tamaño A4 (21*30cm)
para escritorio o stands

Peso: 0.3kg



MINI ROLL UP A3

Código: RU-M3

Roll up tamaño A3 (30*42cm)
para escritorio o stands

Peso: 0.4kg





X-BANNER Especial para interiores

Estructura clásica
en forma de X
aluminio/fibra de vidrio
se le puede adherir gráfico
en tela o lona



X-BANNER ECO

Código: ECO-X 80

X-Banner económico
estructura de fibra de vidrio
ligero y resistente
medida de 80cm*180cm

Peso: 1kg

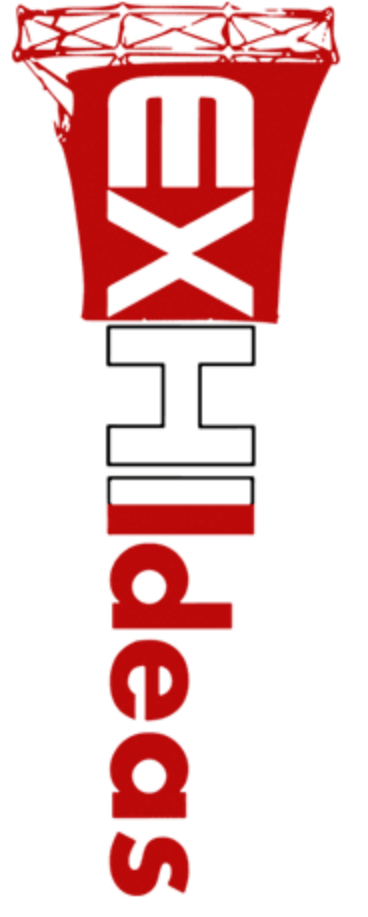

*Bolsa de transporte incluida

X-BANNER ECO

Código: ECO-X 60

X-Banner económico
estructura de fibra de vidrio
ligero y resistente
medida de 60cm*160cm

Peso: 1kg



X-BANNER REFORZADO

Código: X-R 60

X-Banner Reforzado
medida de 60cm*160cm
aluminio y fibra de vidrio

Peso: 1kg

X-BANNER REFORZADO

Código: X-R 80

X-Banner Reforzado
medida de 80cm*180cm
aluminio y fibra de vidrio

Peso: 1kg

X-BANNER REFORZADO

Código: X-R 120

X-Banner Reforzado
medida de 120cm*200cm
aluminio y fibra de vidrio

Peso: 1kg



*Bolsa de transporte incluida

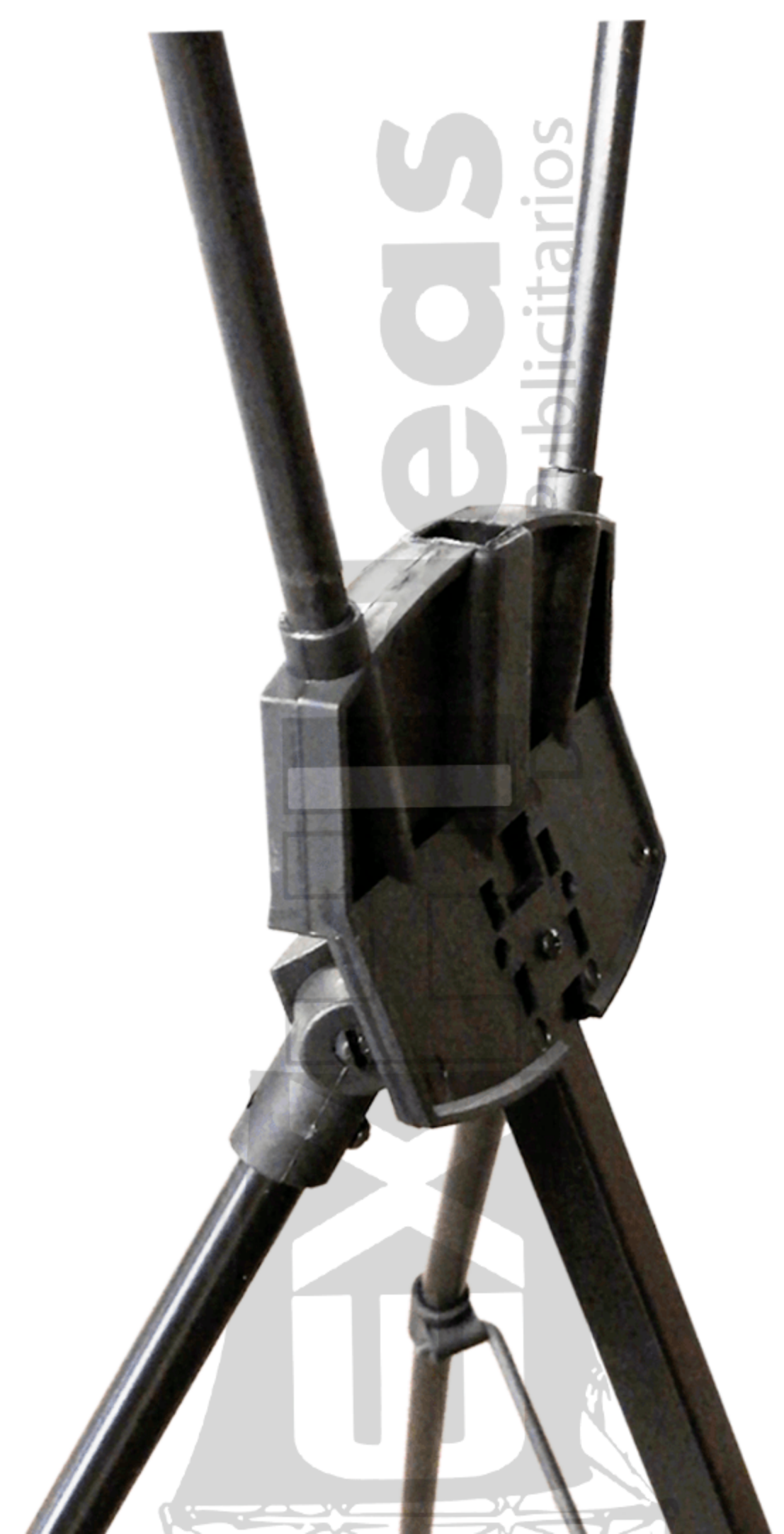
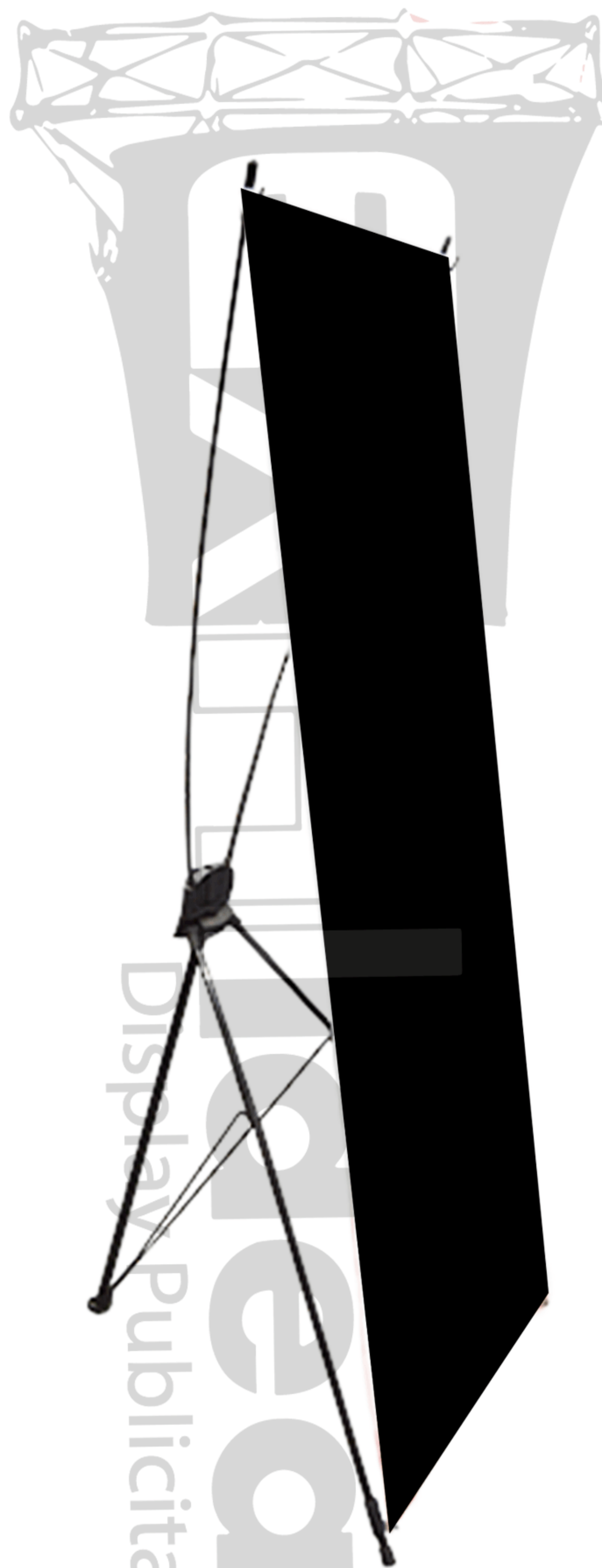



X-BANNER TIPO D

Código: X-BANNER D

X-Banner Reforzado tipo D
medidas ajustables: 60cm*160cm y 80cm*180cm
aluminio y fibra de vidrio

Peso: 1kg

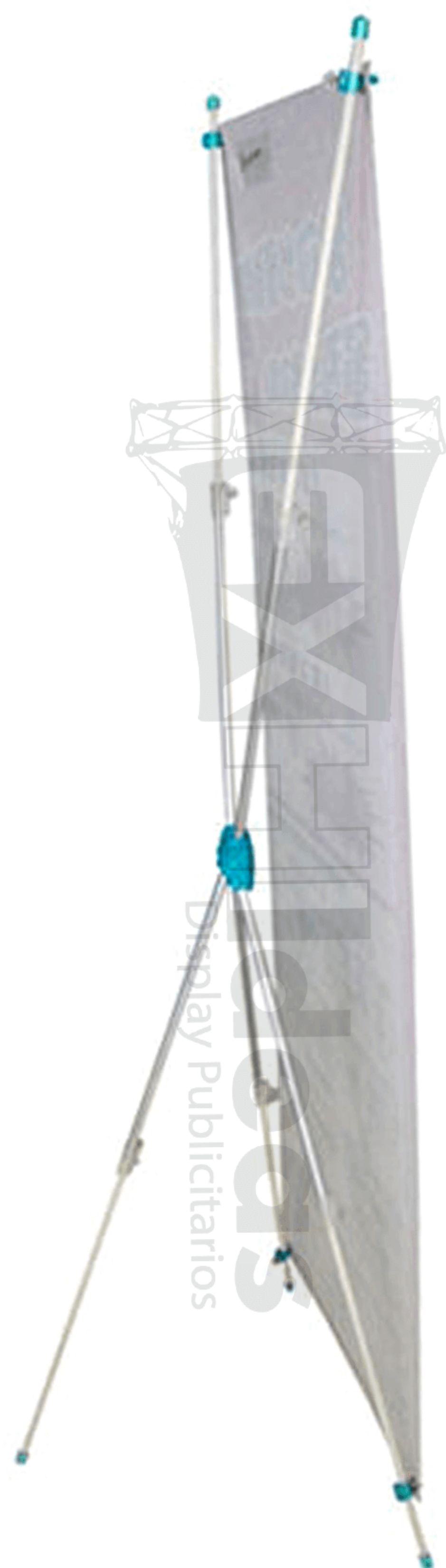
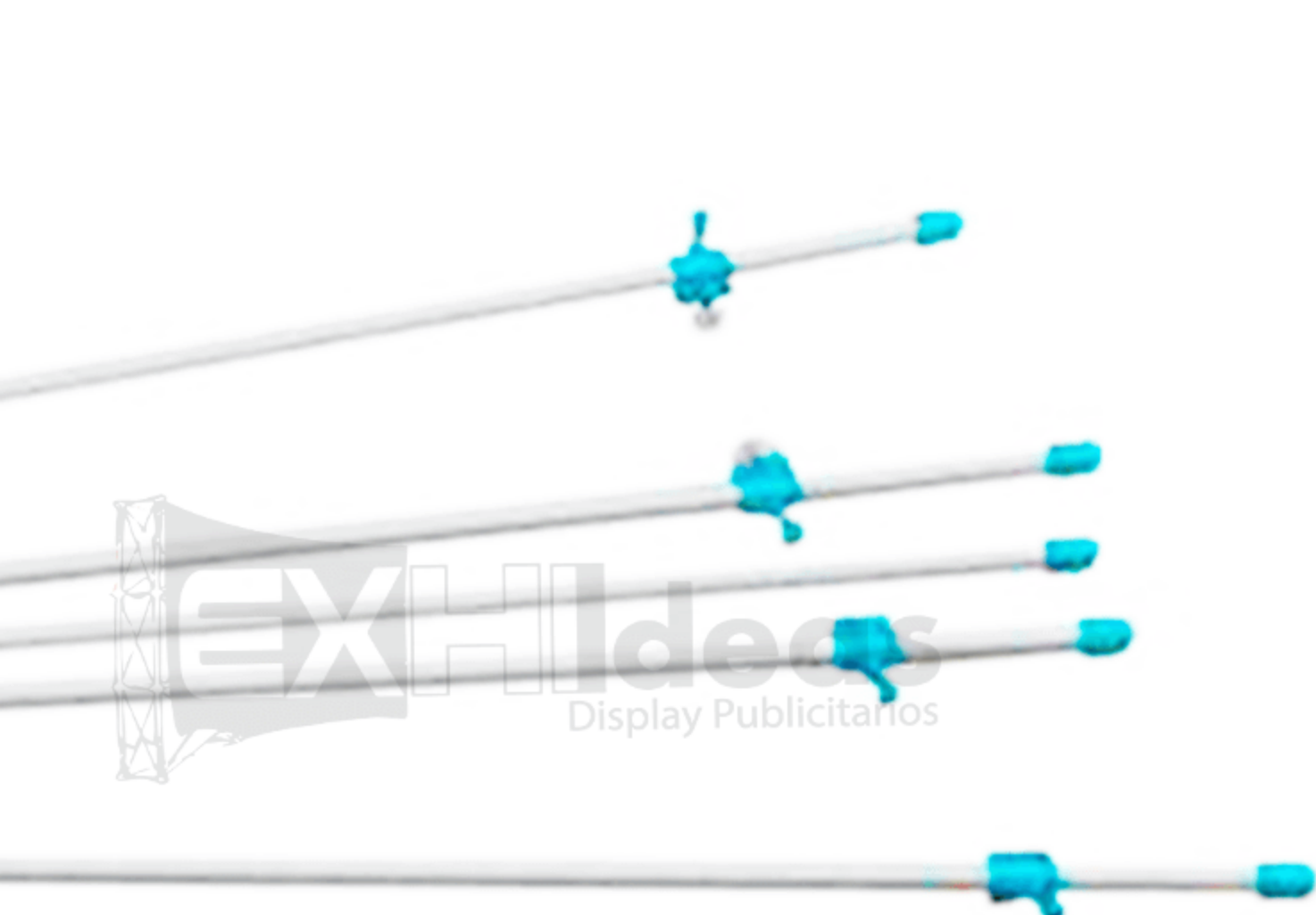

*Bolsa de transporte
incluida





L-BANNER

Código: L-BANNER

Banner en forma de L
medida de 80cm*200cm
aluminio puro

Peso: 1kg

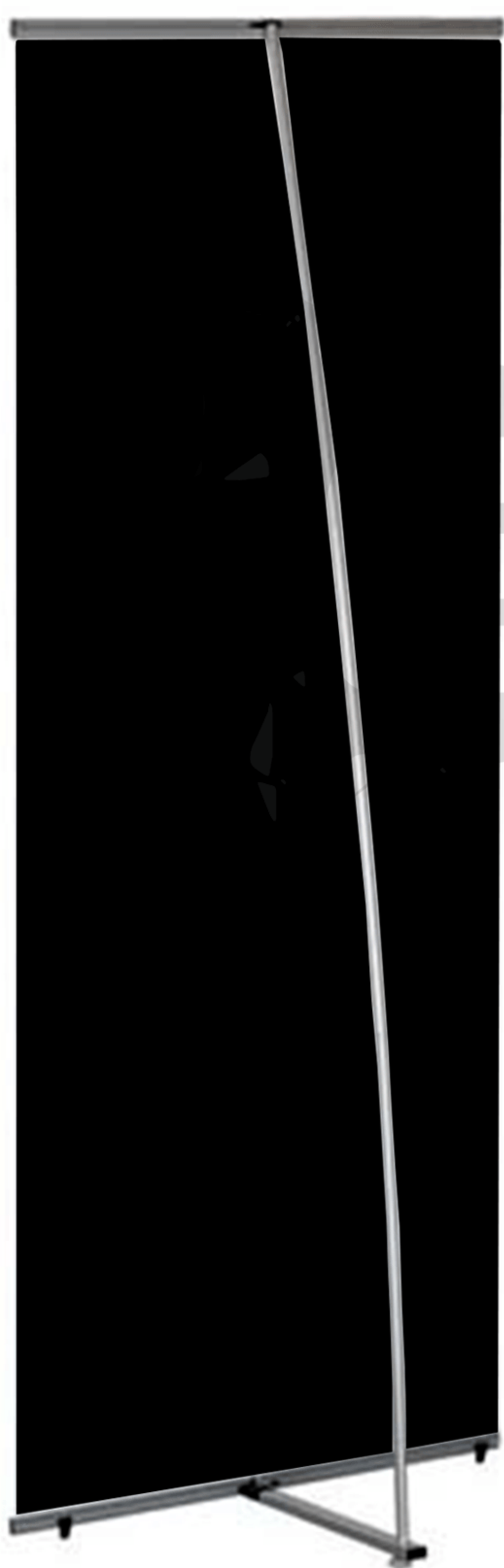

*Bolsa de transporte incluida





X-BANNER BASE AZUL

Código: X-B EXT

X-Banner Base Rellenable para agua o arena
medida de 60cm*160cm y 80cm*180cm
aluminio, fibra de vidrio y plástico
doble vista
especial para exteriores

Peso: 15kg (con base rellena)

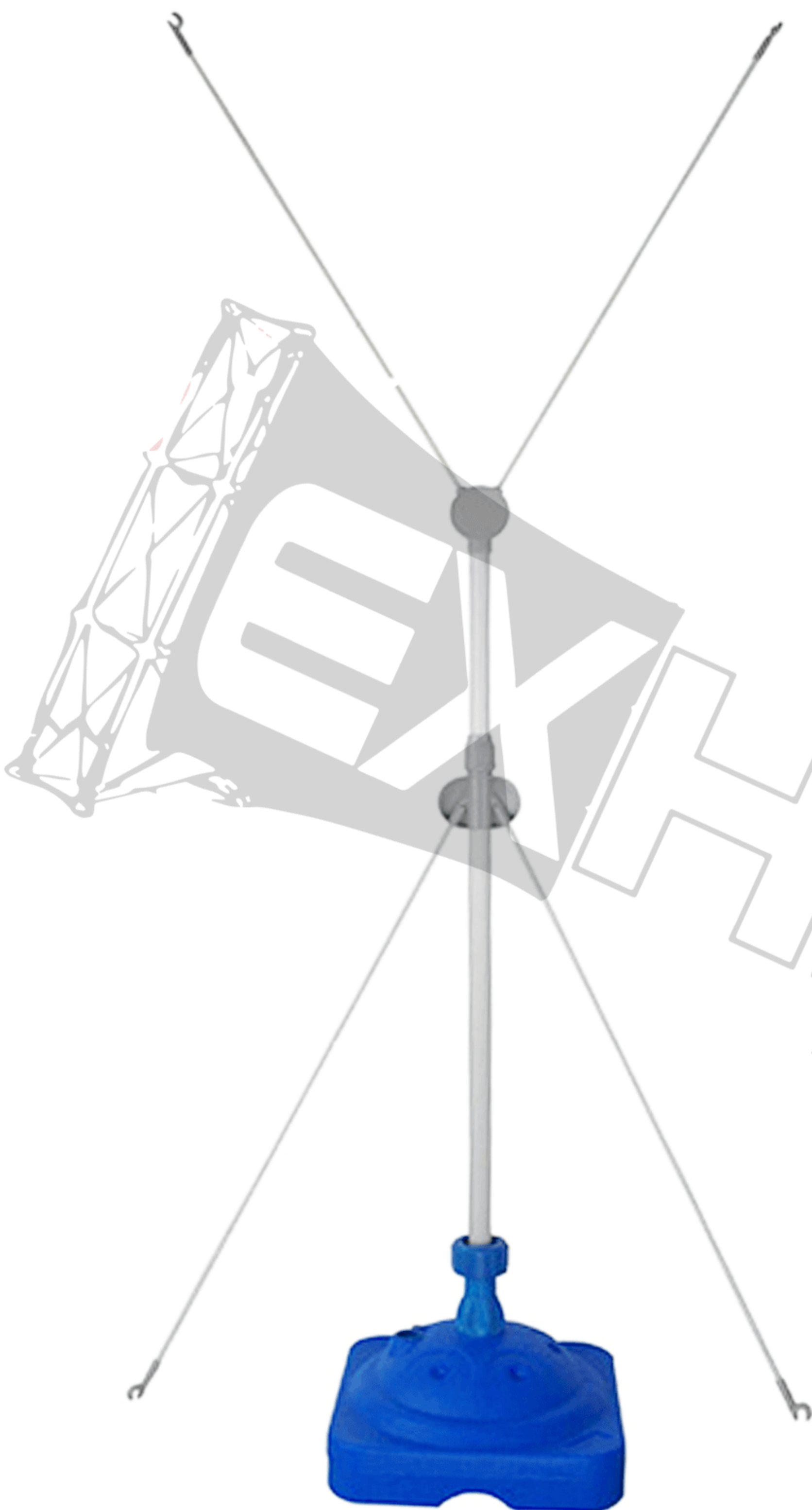

*Bolsa de transporte incluida





X-BANNER EXTERIOR

Código: X-B EX DELUX

X-Banner base rellenable para agua o arena
medidas ajustables: 60cm*160cm y 80cm*180cm
doble vista
aluminio, fibra de vidrio y plástico
especial para exteriores

Peso: 15kg

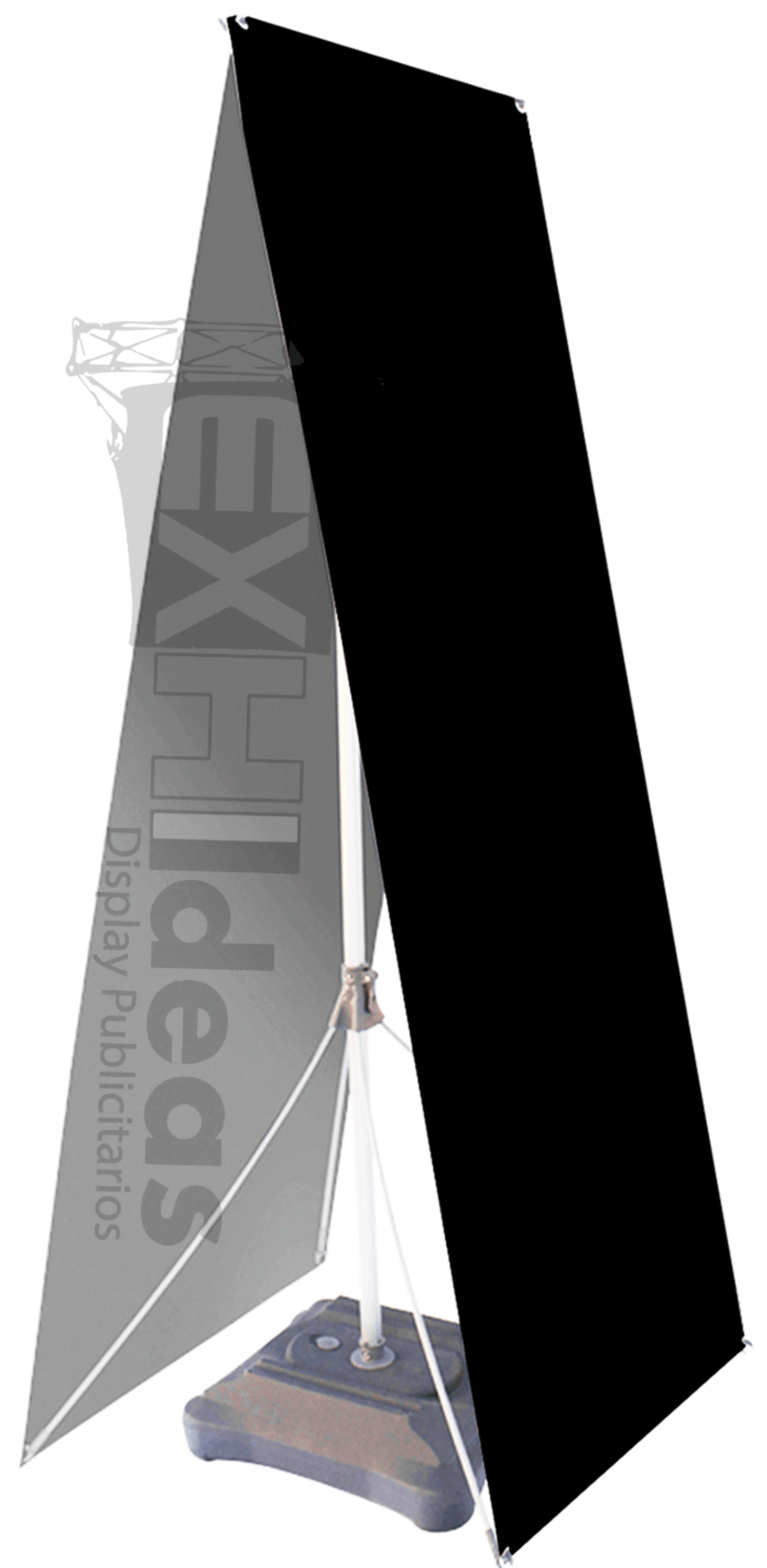

*Con bolsa de transporte incluida



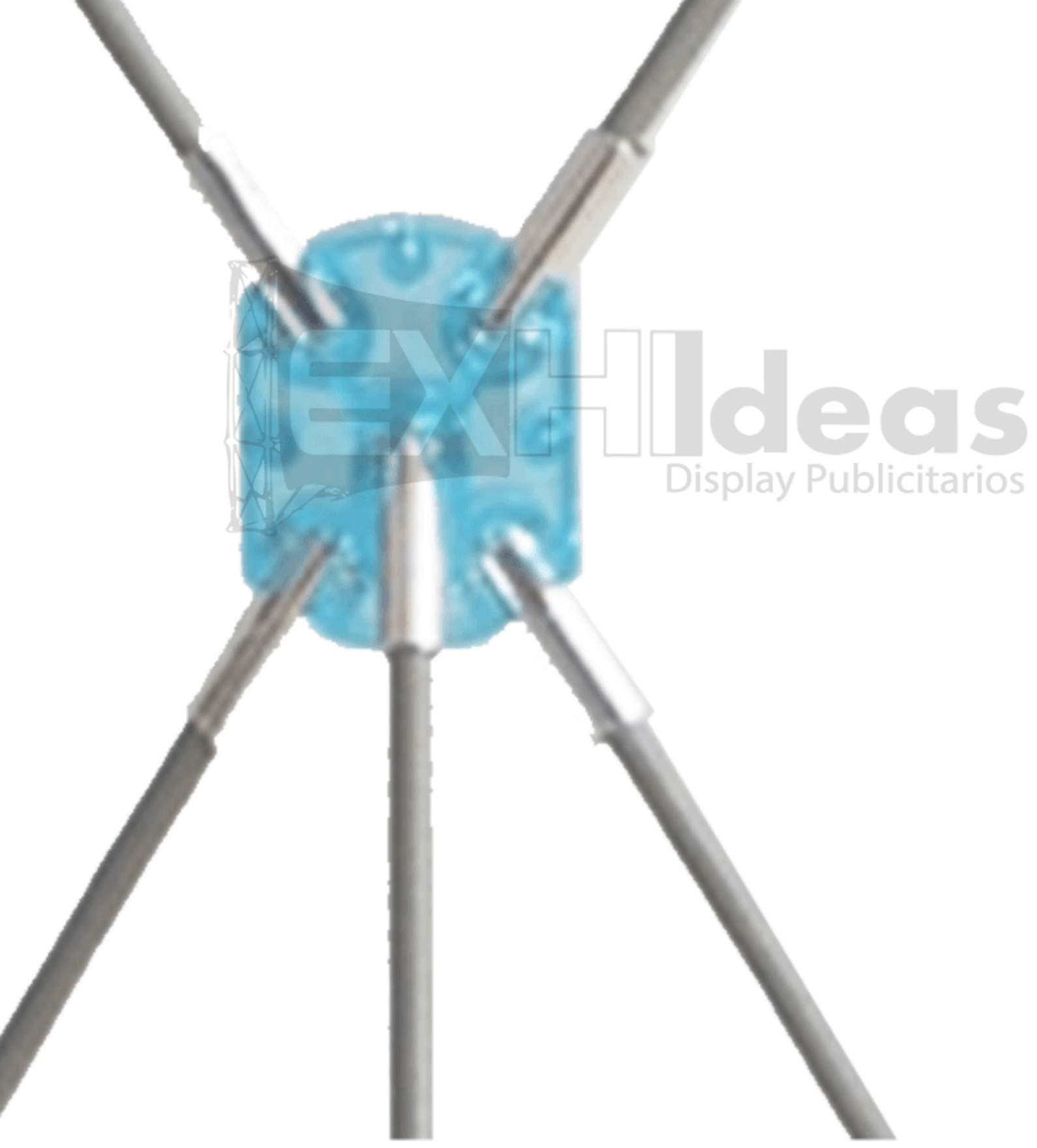

MINI X-BANNER A3

Código: X-B A3

Mini X-Banner
tamaño A3 (30*42cm)
aluminio y fibra de vidrio

Peso: .30kg

MINI X-BANNER A4

Código: X-B A4

Mini X-Banner
tamaño A4 (21*30cm)
aluminio y fibra de vidrio

Peso: .30kg

*A4

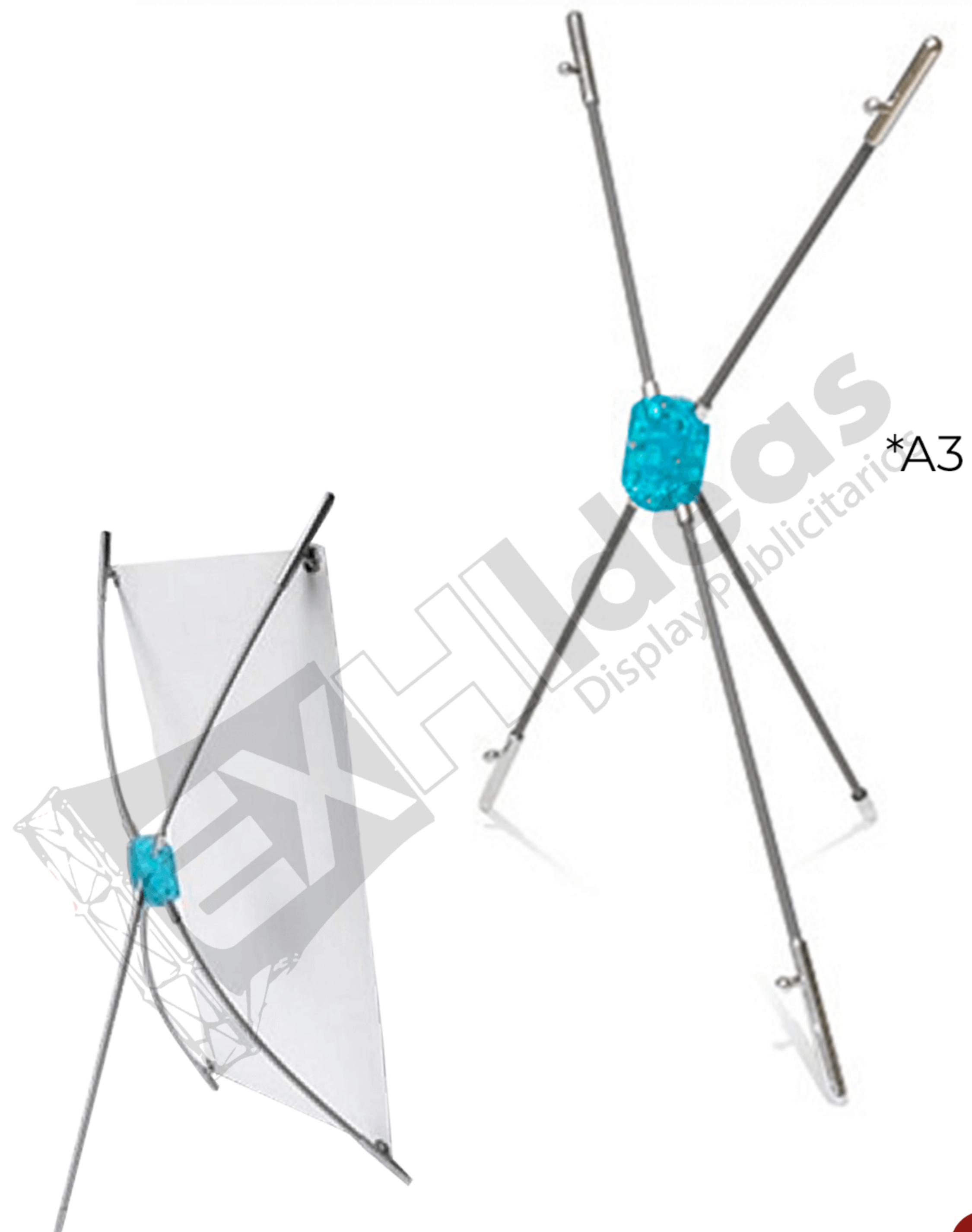

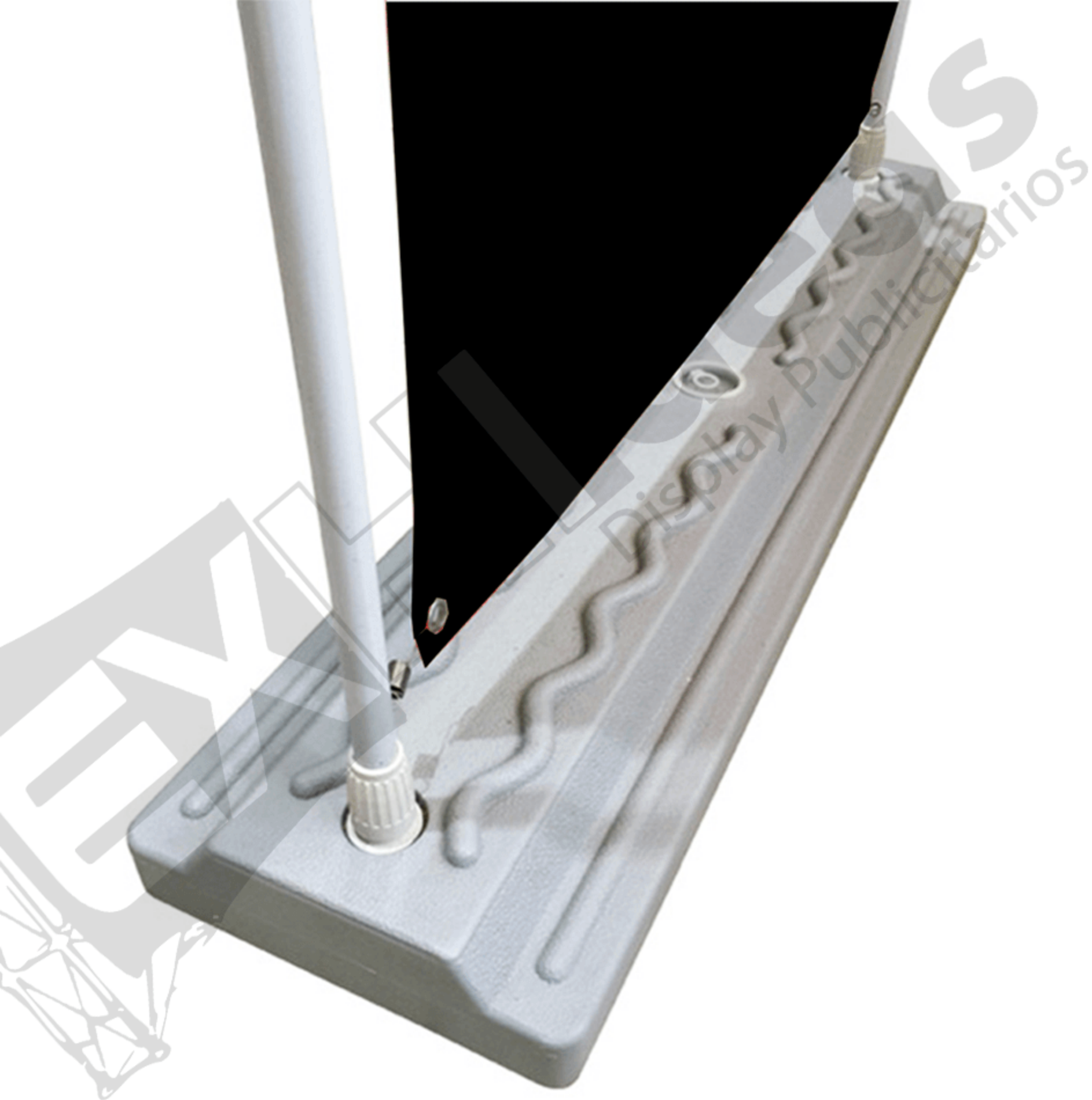

BANNER EXTERIOR

Código: BEA

Banner Base Rellenable
para agua o arena
medida de 80cm*180cm
doble vista
acero y plástico
especial para exteriores

Peso: 2.6kg

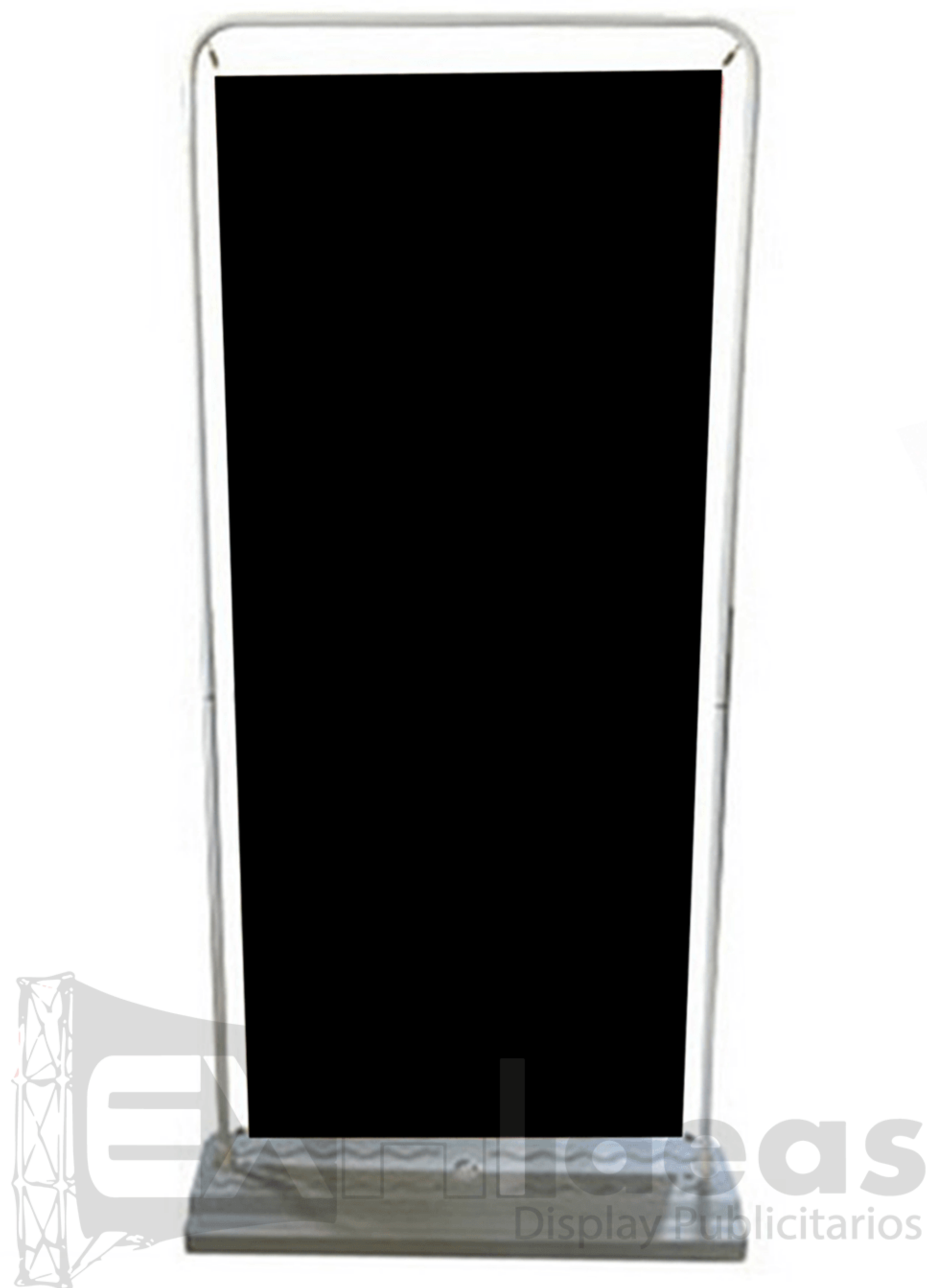

*Con bolsa de transporte incluida





BANNER GOLF

Código: BA-GOLF

Banner especial para tela sublimada
cuenta con guías perimetrales
para costura del banner y armado
4 estacas
especial para exteriores

Peso: 3kg

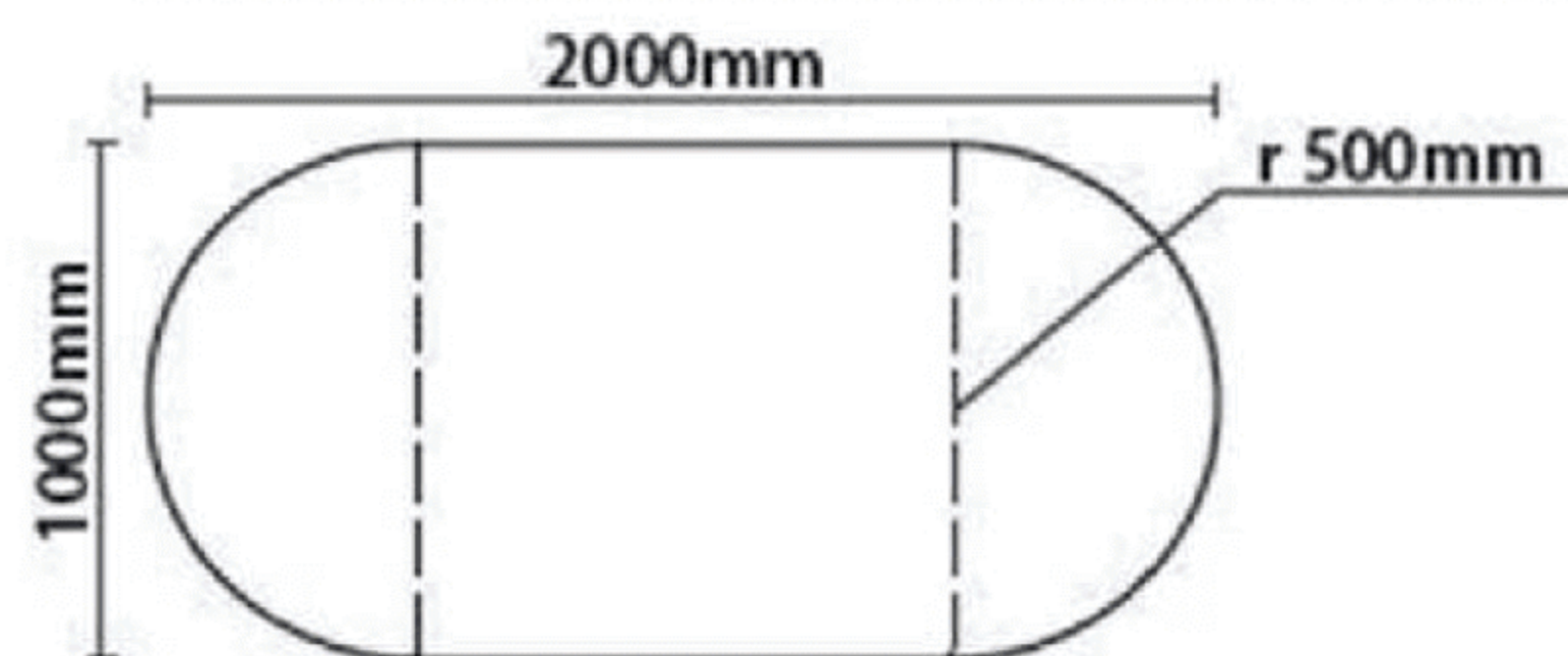
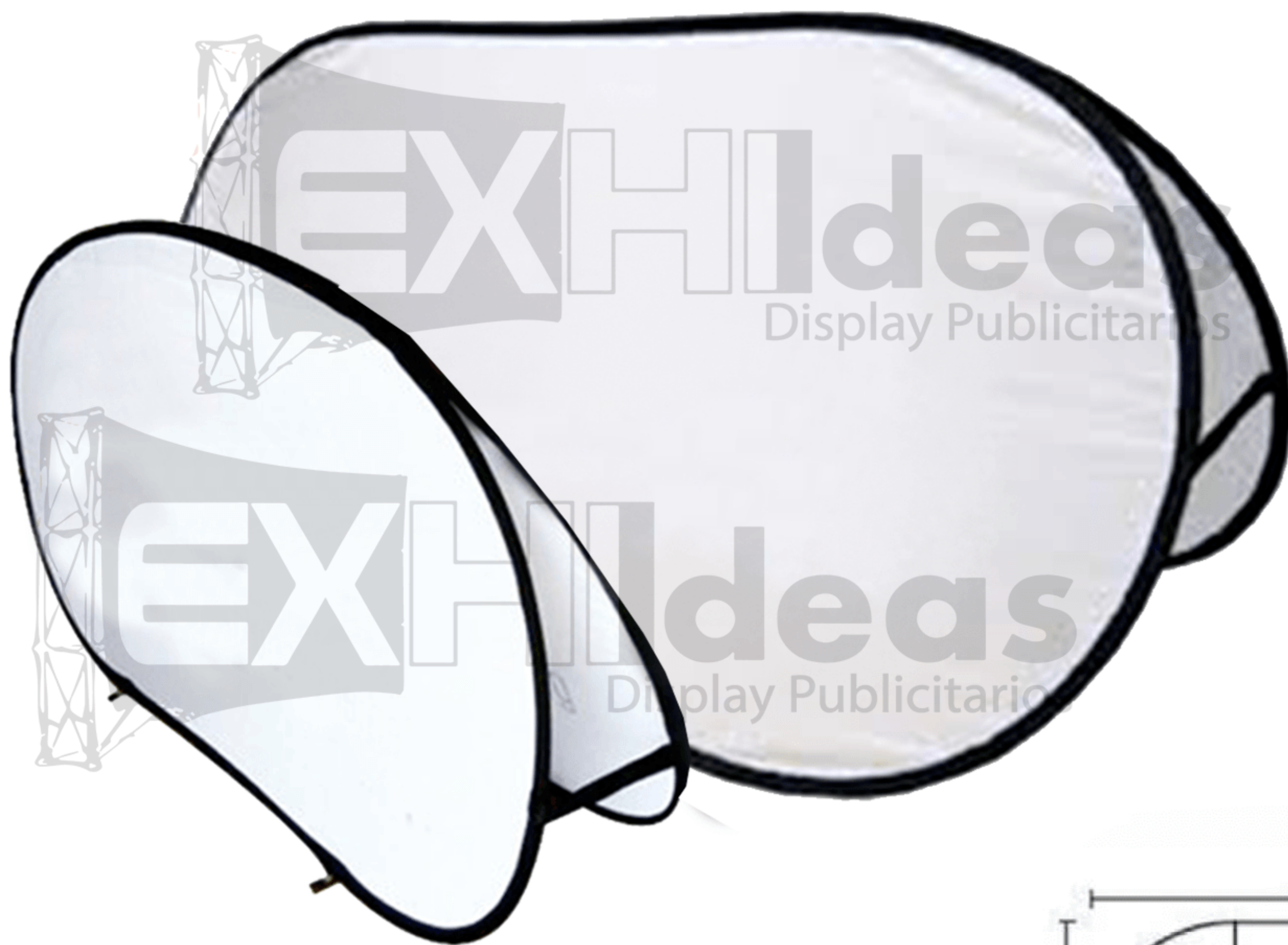

*Medidas



*Estacas



MOCHILA BANNER

Código: MOCH

Mochila X-Banner
reforzada con soportes para
botellas de agua
tamaño de mochila: 61cm*47cm
tamaño de banner: 50cm*100cm





EXH Ideas

Display Publicitarios

FLYING BANNER

Para exteriores

Soporte publicitario en forma de bandera, este puede tomar forma de pluma o gota, su estructura de aluminio, metal y fibra de vidrio crean un acabado resistente y elegante.

Especial para exteriores debido a su base, este se mueve de manera libre evitando que el aire lo derribe para tela sublimada



BANNER FLYING S

Código: FLYING-S

Bandera banner premium
medida de 3.5m
base de metal, estructura de aluminio
baras flexibles que le dan forma
a la bandera

Peso: 5kg

BANNER FLYING M

Código: FLYING-M

Bandera banner premium
medida de 4.5m
base de metal, estructura de aluminio
baras flexibles que le dan forma
a la bandera

Peso: 5kg

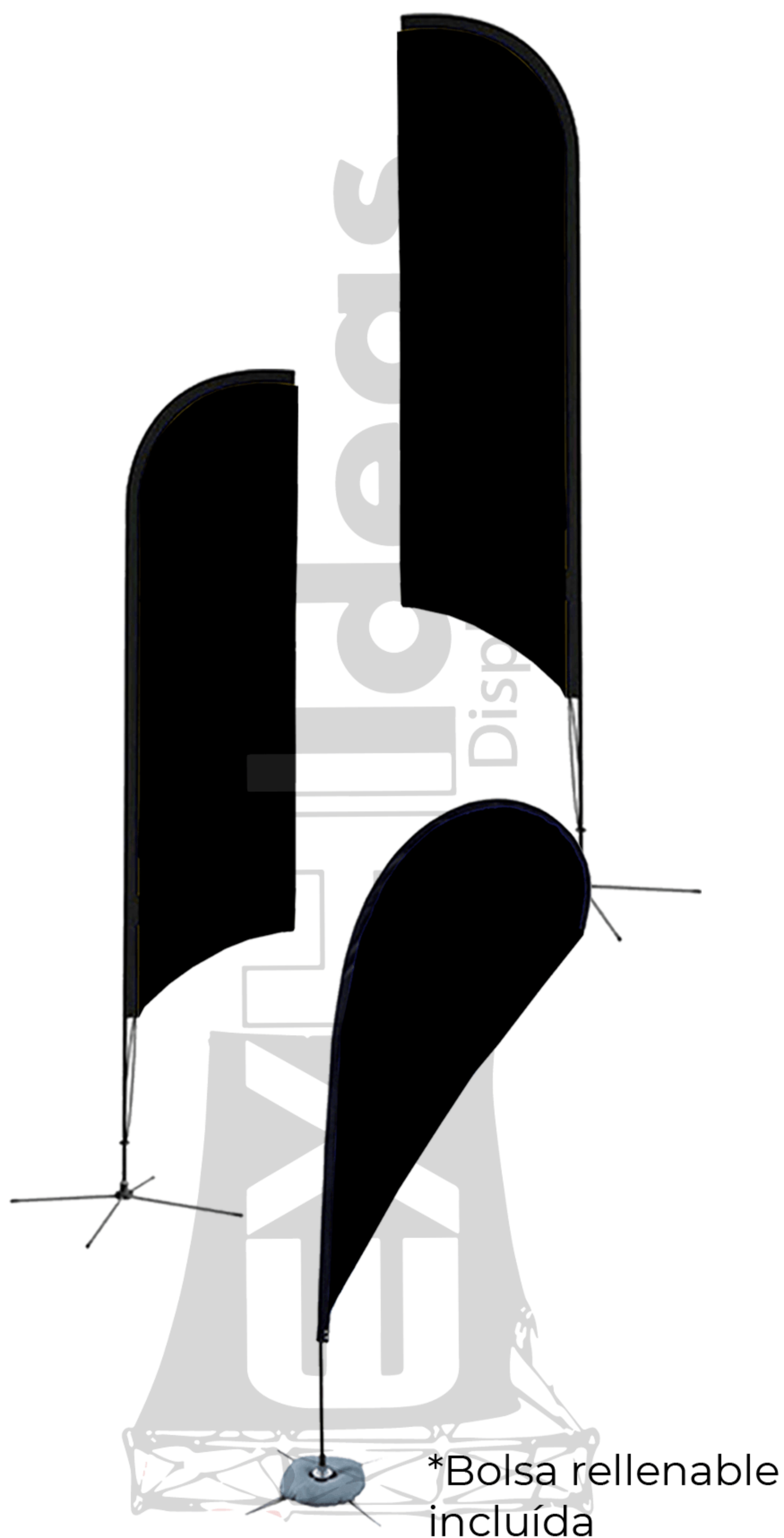

BANNER FLYING

Código: FLYING

Bandera banner premium
medida de 5.9m
base de metal, estructura de aluminio
baras flexibles que le dan forma
a la bandera

Peso: 5kg

Maleta de transporte
incluída*



BANNER FLYING S ESTACA

Código: FLYING-S

Bandera banner premium
medida de 3.5m
estaca de metal, estructura de aluminio
baras flexibles que le dan forma
a la bandera

Peso: 5kg

BANNER FLYING M ESTACA

Código: FLYING-M

Bandera banner premium
medida de 4.5m
estaca de metal, estructura de aluminio
baras flexibles que le dan forma
a la bandera

Peso: 5kg

BANNER FLYING ESTACA

Código: FLYING

Bandera banner premium
medida de 5.9m
estaca de metal, estructura de aluminio
baras flexibles que le dan forma
a la bandera

Peso: 5kg

Maleta de transporte
incluída*

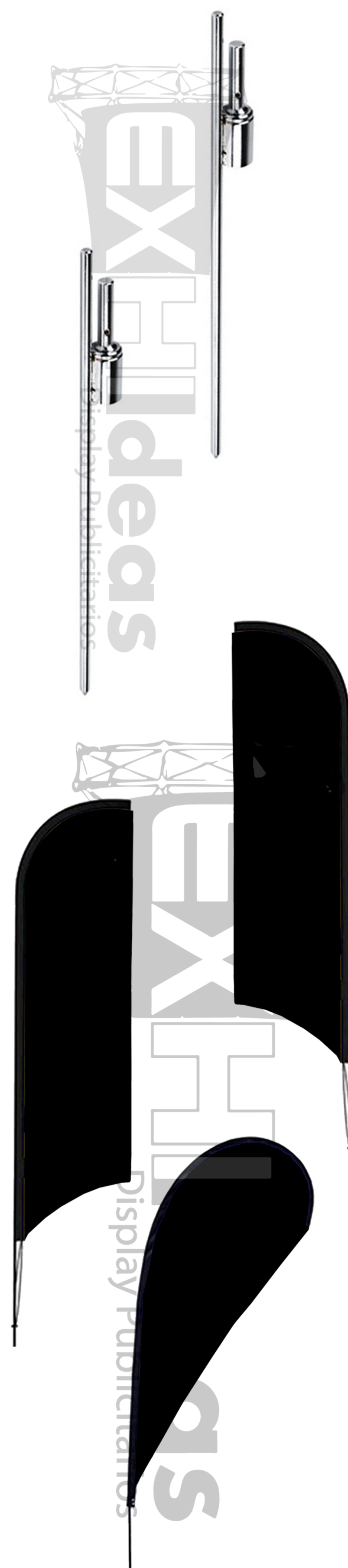

BANNER FLYING S ECONÓMICO

Código: ECO BANDERA IMP-S

Bandera banner económica de línea
medida de 3.4m
estaca de metal, estructura de aluminio
baras flexibles que le dan forma
a la bandera

BANNER FLYING M ECONÓMICO

Código: ECO BANDERA IMP-M

Bandera banner económica de línea
medida de 4.5m
estaca de metal, estructura de aluminio
baras flexibles que le dan forma
a la bandera



Maleta de transporte
incluída*

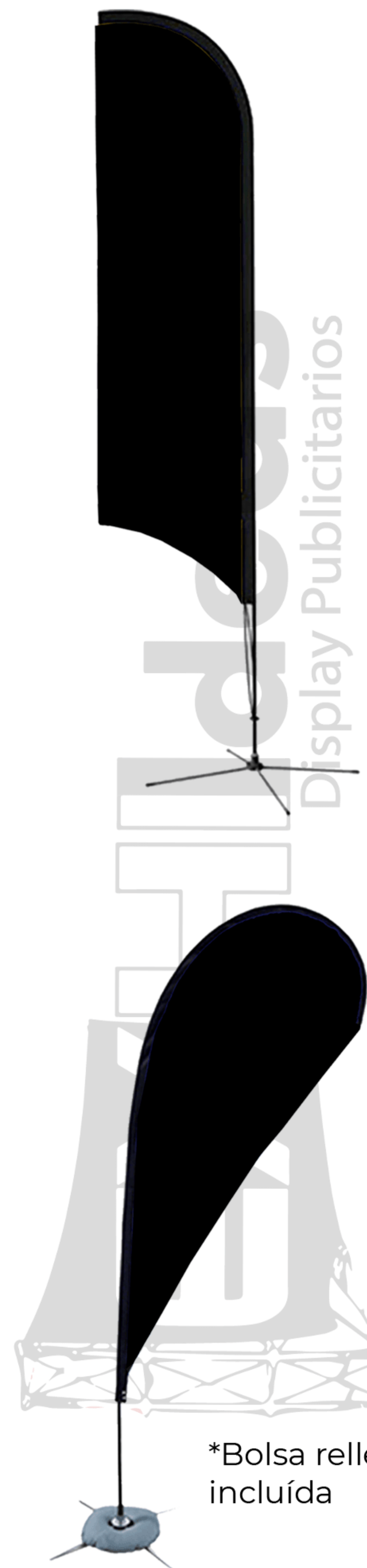

*Bolsa rellenable
incluída

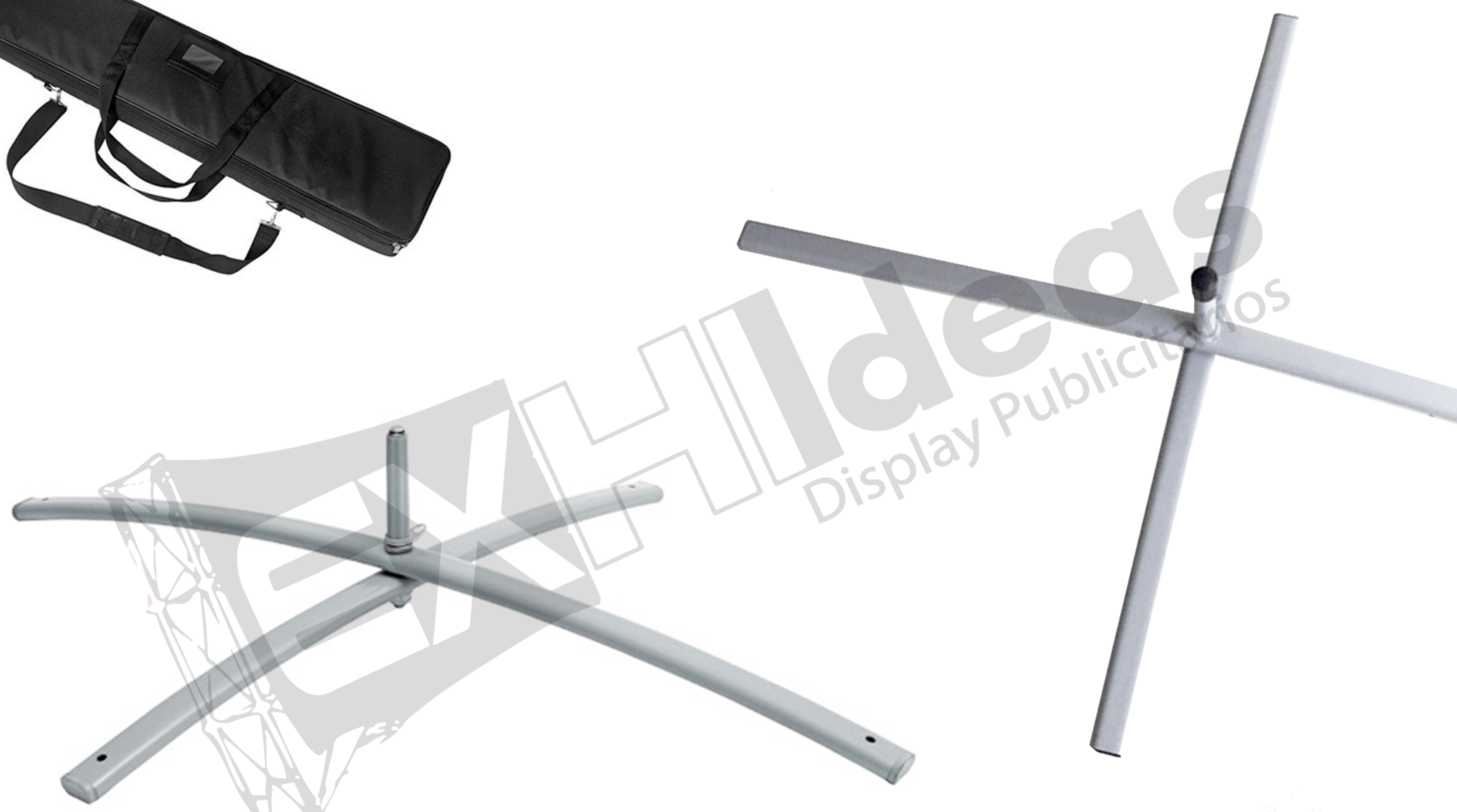

BANNER FLYING S FABRICADA

Código: FLYING ECO-S

Bandera banner fabricada
medida de 2.5m
estaca de metal, estructura de aluminio
puede ser de base o estaca
solo toma forma de pluma (vela)



BANNER FLYING M FABRICADA

Código: FLYING ECO-M

Bandera banner fabricada
medida de 3.5m
estaca de metal, estructura de aluminio
puede ser de base o estaca
solo toma forma de pluma (vela)

BANNER FLYING FABRICADA

Código: FLYING ECO

Bandera banner fabricada
medida de 4.5m
estaca de metal, estructura de aluminio
puede ser de base o estaca
solo toma forma de pluma (vela)





MINI BANDERA ESCRITORIO

Código: MINI FLYING

Mini bandera banner para escritorio
tamaño 15cm * 30cm
base de aluminio y
varilla fibra de vidrio

Peso: 0.17kg

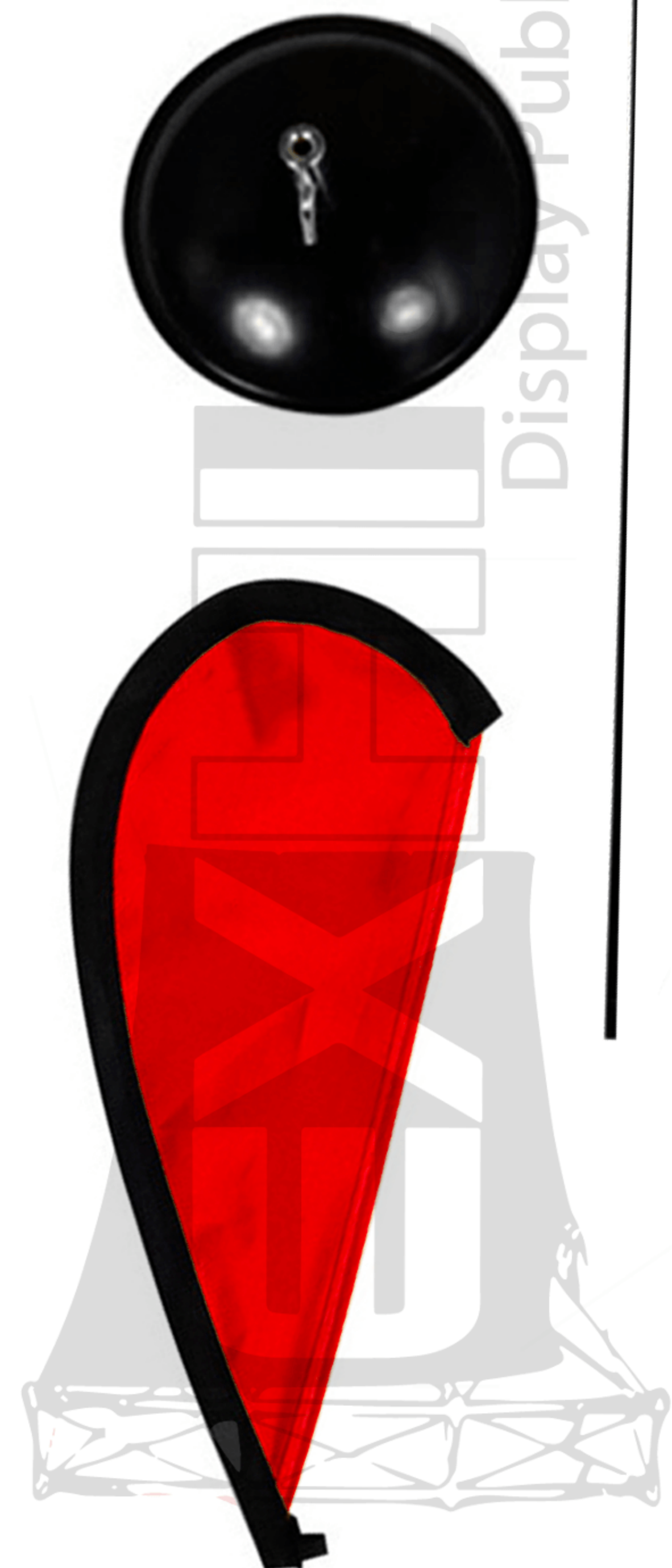



MOCHILA BANDERA

Código: MOCHILA BANDERA

Mochila reforzada ligera
cuenta con soportes para botellas de agua
y almacenamiento de catálogos
medida del gráfico: 43cm * 125cm
especial para tela sublimada

Peso: 1.6kg



DEMO STAND

Para interiores/exteriores

Estructura publicitaria que facilita la atención al cliente
material de PVC o MDF
es portátil y sirve para cualquier evento
(ferias, exposiciones, muestras de producto
promociones , etc)





DEMO STAND PVC

Código: PT-1

Demo stand de PVC recto con mesa de muestreo amplia copete montable especial para rotulación
200cm * 83cm

Peso: 8kg



*Maleta de transporte incluida

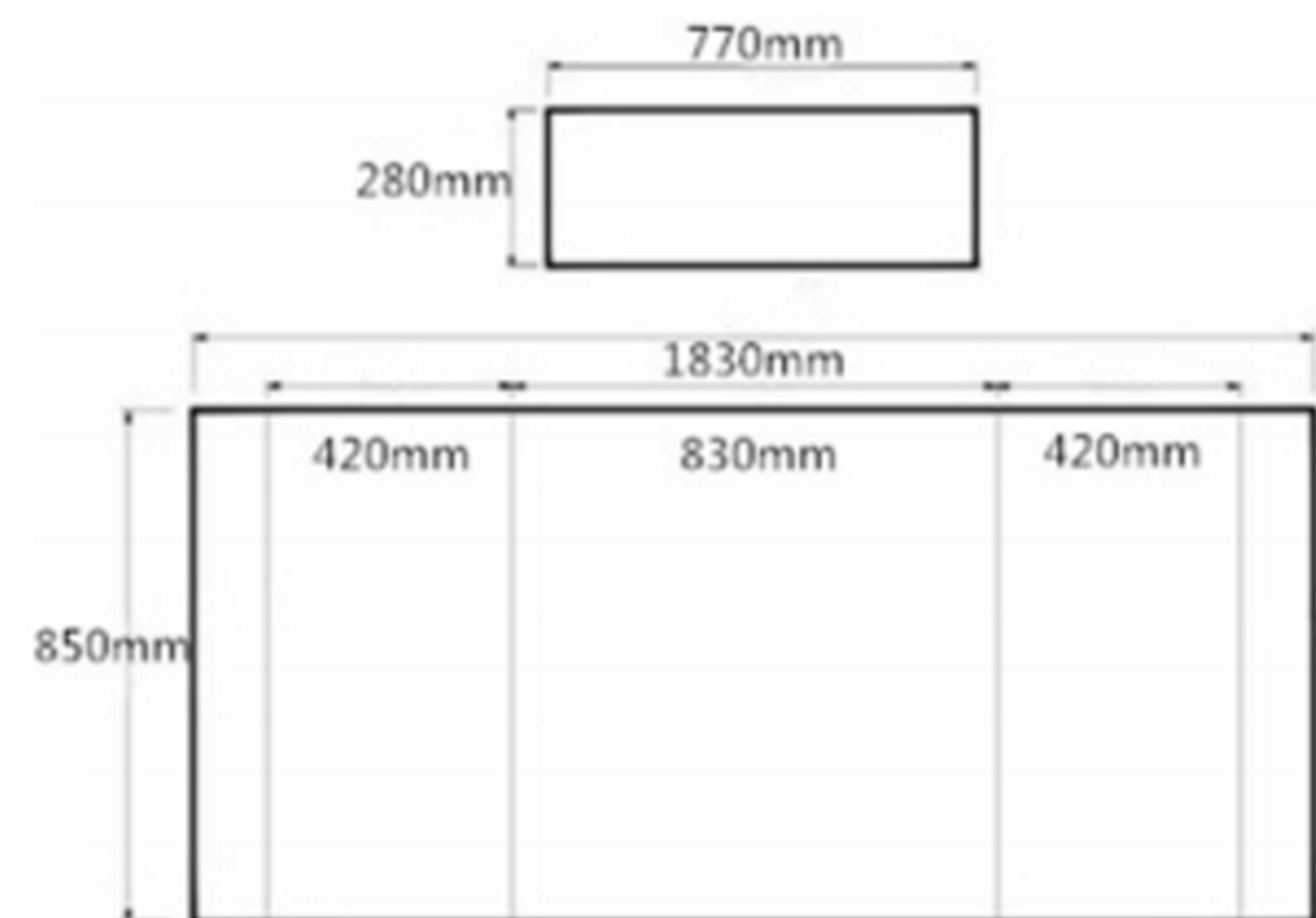

DEMO STAND PVC

Código: PT-2

Demo stand de PVC curvo
con mesa de muestreo amplia
copete montable
especial para rotulación
200cm * 123cm

Peso: 8kg

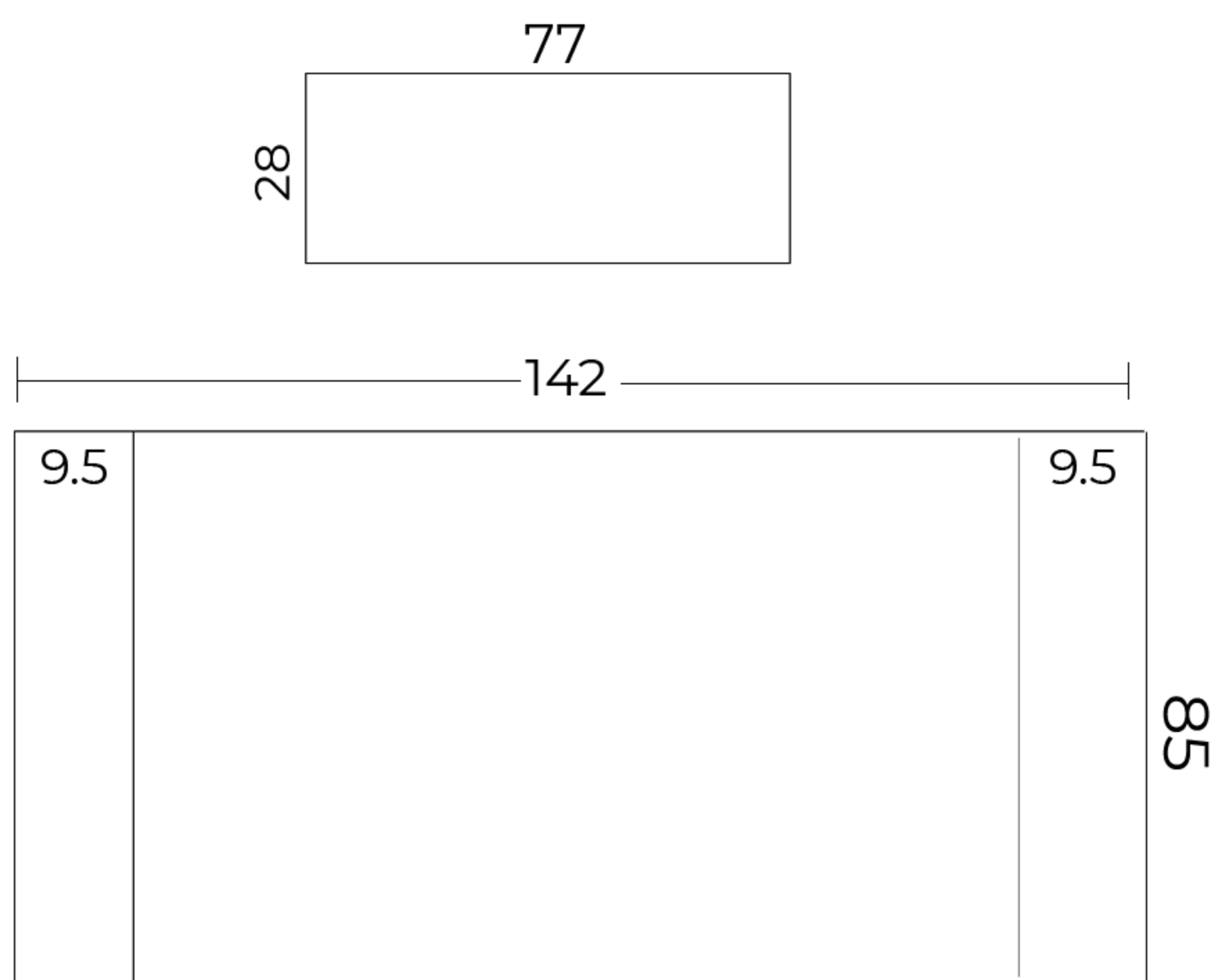

*Maleta de transporte
incluída





*Maleta de transporte
incluída

DEMO STAND PVC DELUX

Código: PT-5

Demo stand de PVC reforzado recto
con mesa de muestreo más amplia
copete montable
especial para rotulación
200cm*83cm

Peso: 8kg

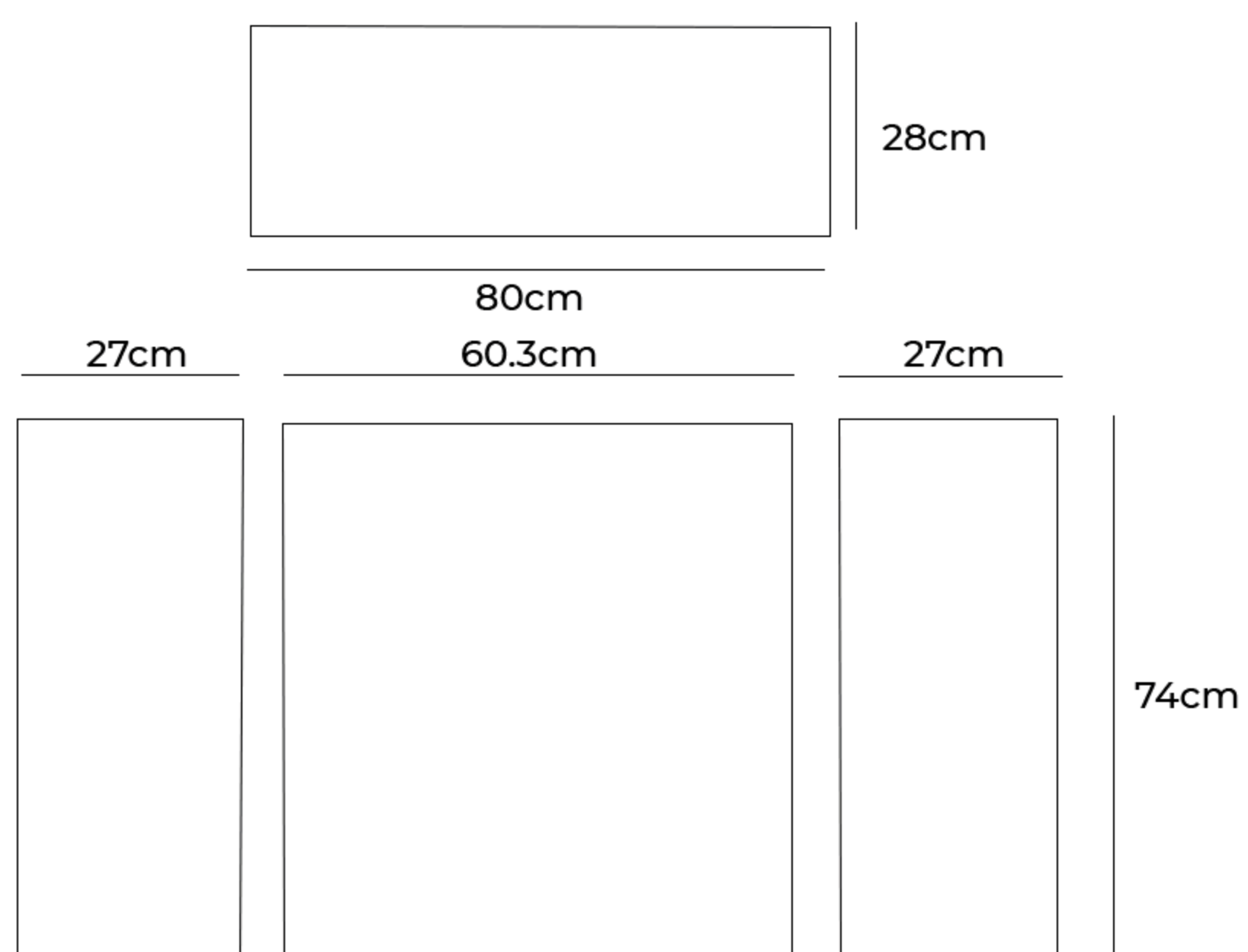
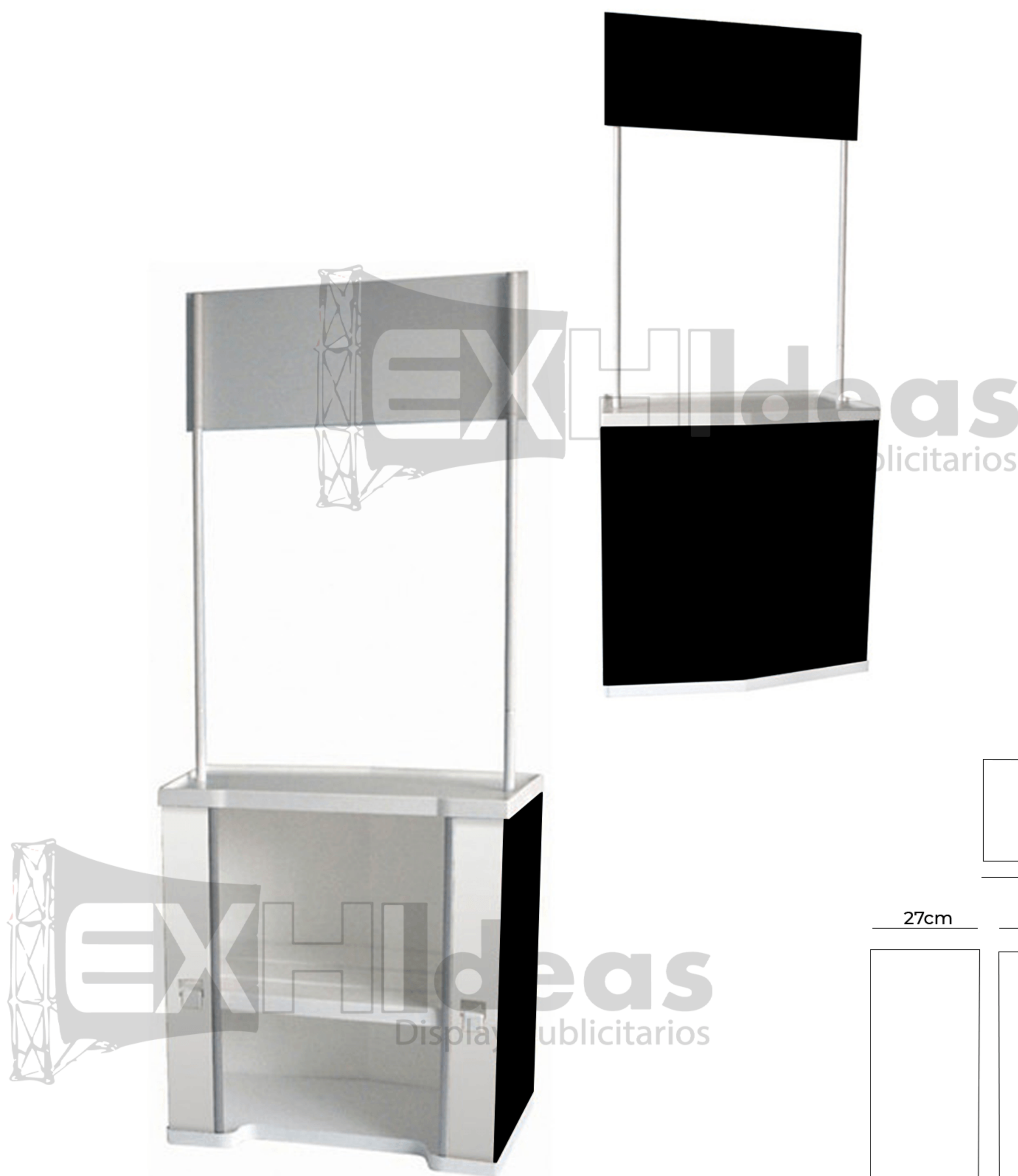



DEMO STAND MDF

Código: PT-3

Demo stand estructura de aluminio
repisas de MDF diseño con puertas
57cm * 30cm

Peso: 11kg



*Maleta de transporte
incluida

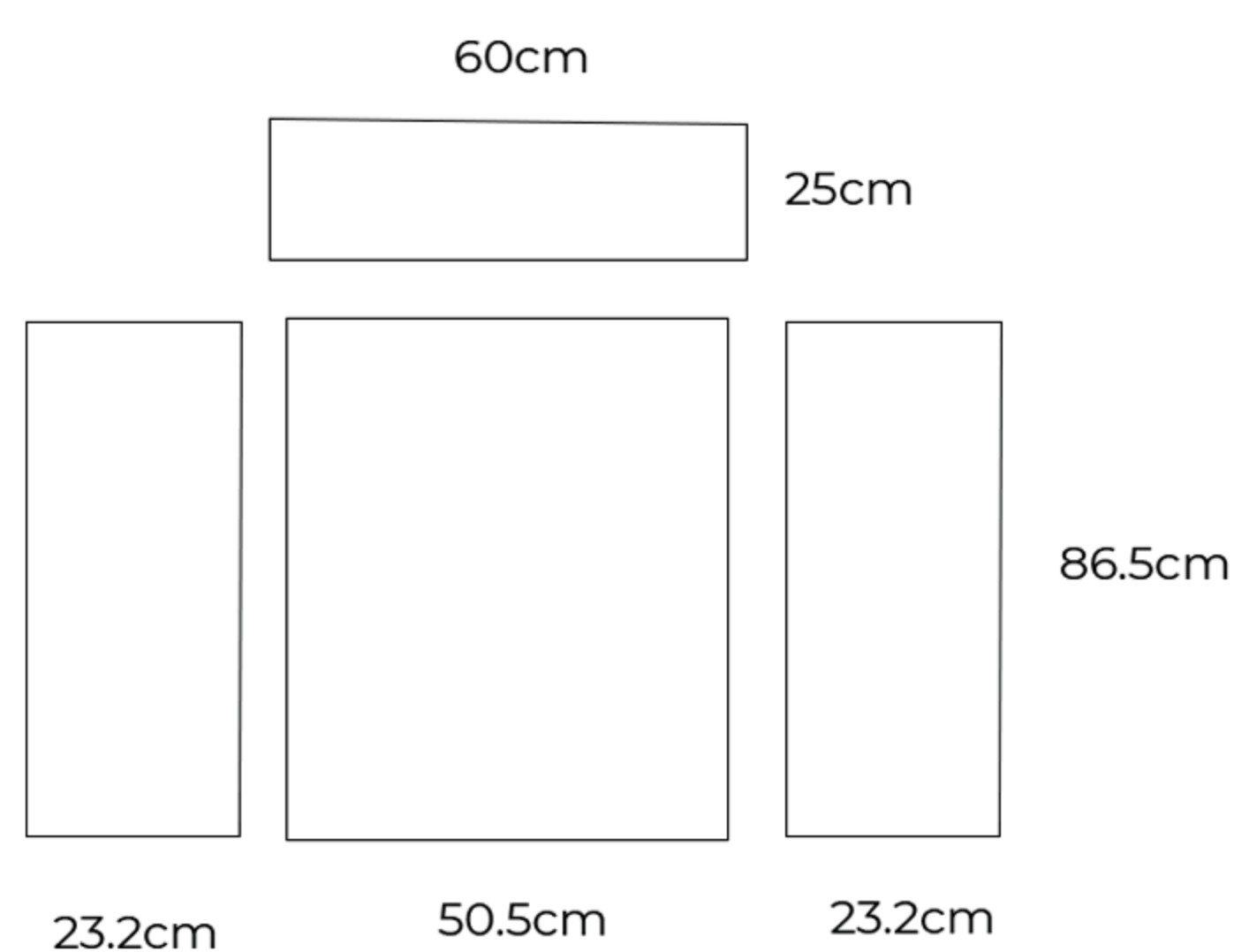

DEMO STAND MDF

Código: PT-4

Demo stand estructura de aluminio
repisas de MDF diseño con puertas
cerradura (llaves incluidas) y ruedas
57cm * 30cm

Peso: 11kg

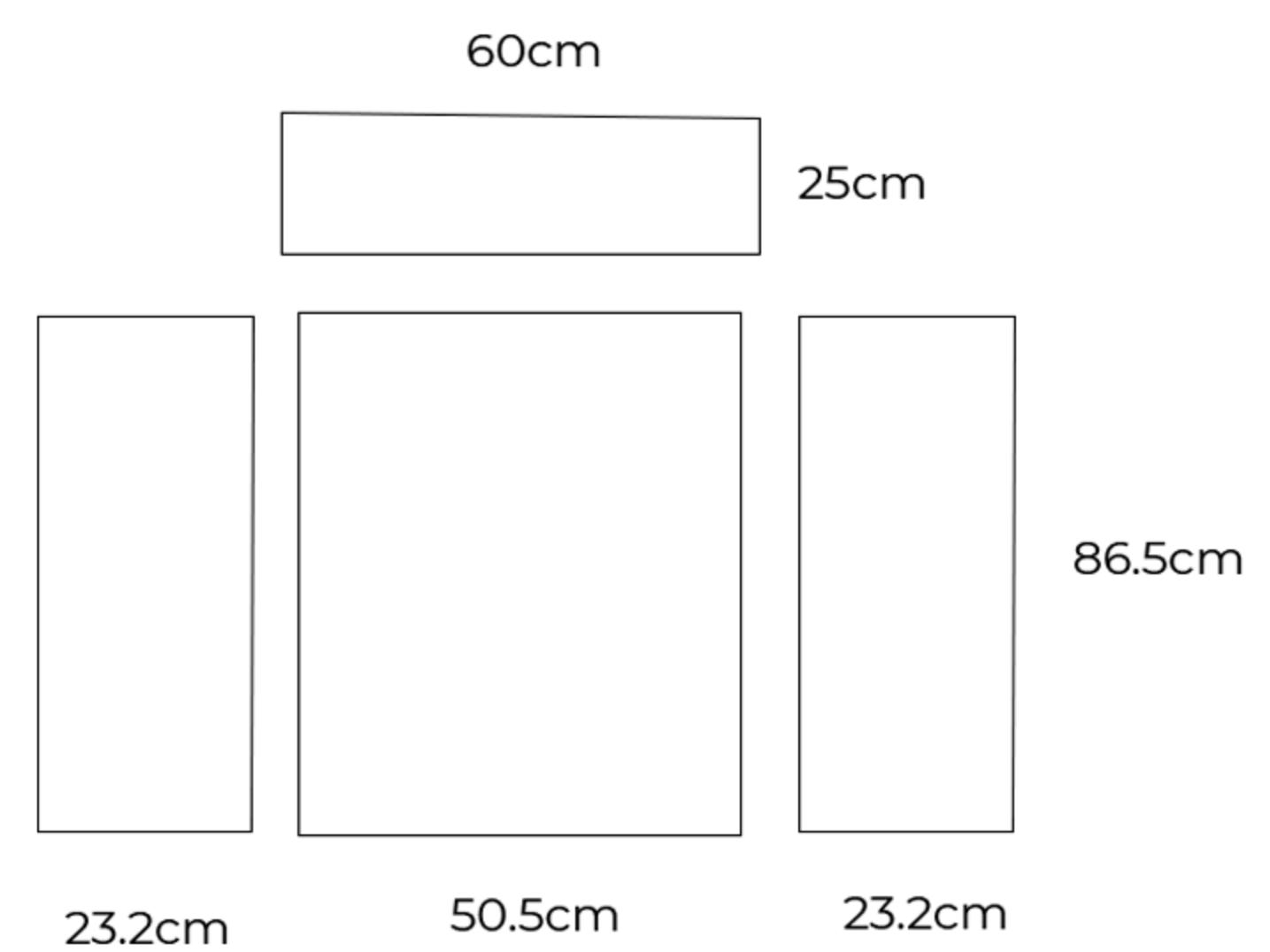

*Maleta de transporte
incluída



DEMO POP UP

Código: POP UP

Demo stand estructura de aluminio
repisa de MDF especial para tela sublimada
medida de gráfico 200cm * 95cm

Peso: 12.8kg



*Maleta de transporte
incluída





TORRE TWISTER

Código: TOWER T2A

Estructura retráctil de aluminio
bases media luna de PVC diámetro 45 cm
largo 192cm
con luz led

Peso: 10kg



*Maleta de transporte
incluída

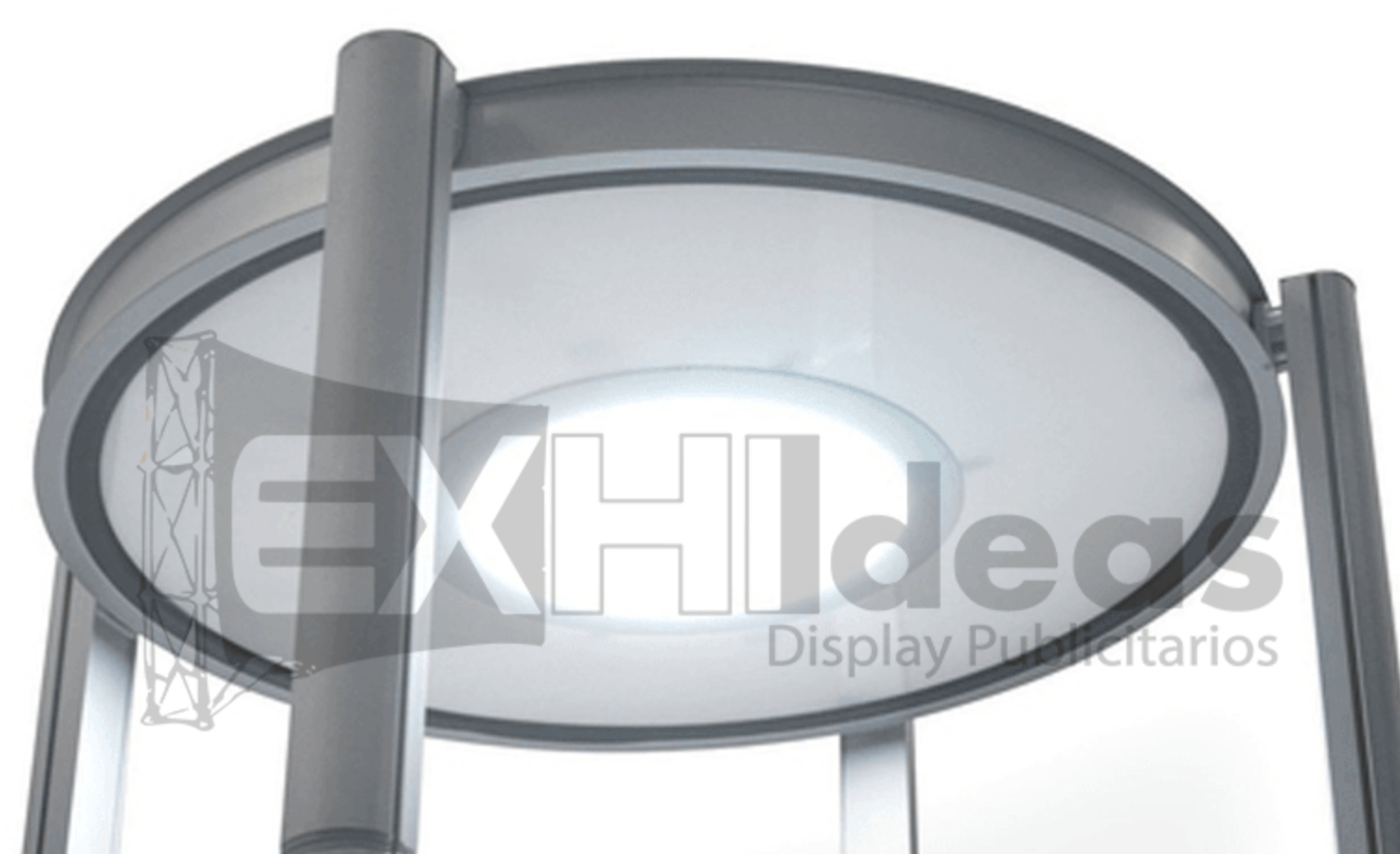



DEMO POP UP TUBULAR

Código: POP UP TUBE

Demo stand tubular estructura de aluminio
repisa de MDF especial para tela sublimada
medida de gráfico 240cm * 100cm
incluye cierre y silicón perimetral para adherir
al gráfico

Peso: 7kg



*Maleta de transporte
incluída



MURO O PARED PUBLICITARIO

Para exteriores/interiores

Estructuras de aluminio ligeras y resistentes que permiten exhibir gráficos de gran formato, especiales para tela sublimada



EXH Ideas
Display Publicitarios

EXH Ideas



MURO AJUSTABLE

Código: V-POP AJUSTABLE

Marco de aluminio grueso
ajustable 2.27m * 2.27m / 2.27 * 3.06m
vista doble
placas de acero
tanques rellenables
(cada tanque lleno aumenta 20kg
de peso soporte)

Peso: 18kg



*Maleta de transporte
incluída





MURO EXPANDIBLE

Código: V-POP 3X3

Estructura de aluminio alta calidad
perimetro con velcro para adherir
el gráfico, medida de 2.27m * 2.27m

Peso: 14kg



*Maleta de transporte
incluída

MURO EXPANDIBLE

Código: V-POP 3X4

Estructura de aluminio alta calidad
perimetro con velcro para adherir
el gráfico, medida de 3.06m * 2.27m

Peso: 16kg

MURO EXPANDIBLE

Código: V-POP 4X5

Estructura de aluminio alta calidad
perimetro con velcro para adherir
el gráfico, medida de 3.06cm * 3.82cm

Peso: 17kg

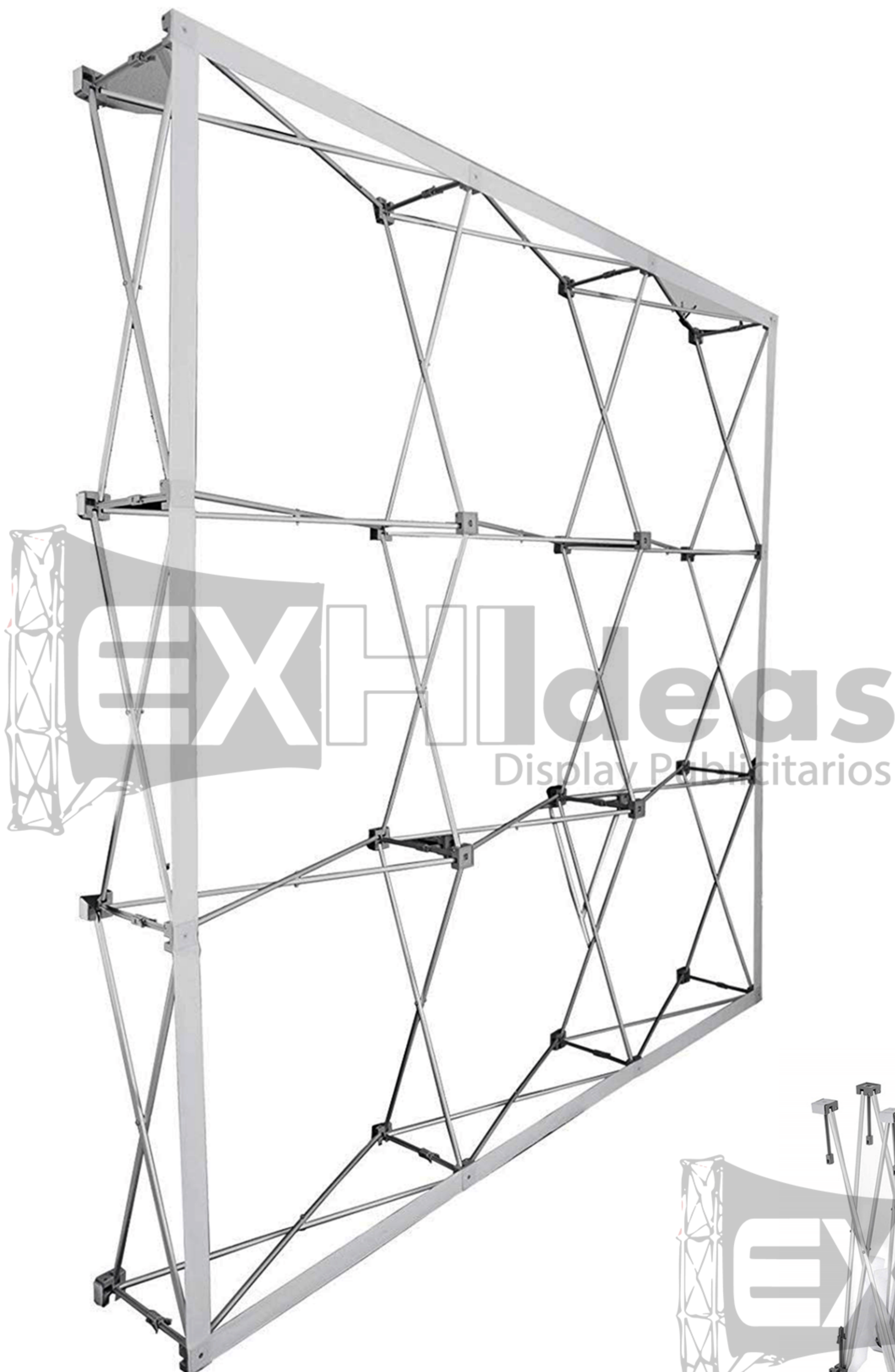

*Velcro

*Lámparas
halógenas incluídas
(o pueden no incluirse)



MURO EXPANDIBLE

Código: BB-CURVE 3X3M

Estructura curva de aluminio alta calidad
perimetro con velcro para adherir el gráfico
medida 2.27m * 2.27m

Peso: 14kg



*Velcro

MURO EXPANDIBLE

Código: BB-CURVE 3X4M

Estructura curva de aluminio alta calidad
perimetro con velcro para adherir el gráfico
medida 2.27m * 3.06m

Peso: 16kg



*Maleta de transporte
incluída



*Lámparas
halógenas incluídas
(o pueden no incluirse)





MURO TUBULAR RECTO

Código: TUBE R

Estructura tubular de aluminio ensamblable recto que moldea el gráfico de tela sublimada (doble vista) medida de 2.29m * 29.2m

Peso: 13kg

MURO TUBULAR RECTO

Código: TUBE R-6M

Estructura tubular de aluminio ensamblable que moldea el gráfico de tela sublimada (doble vista) medida de 6.96m * 29.2m

Peso: 18kg

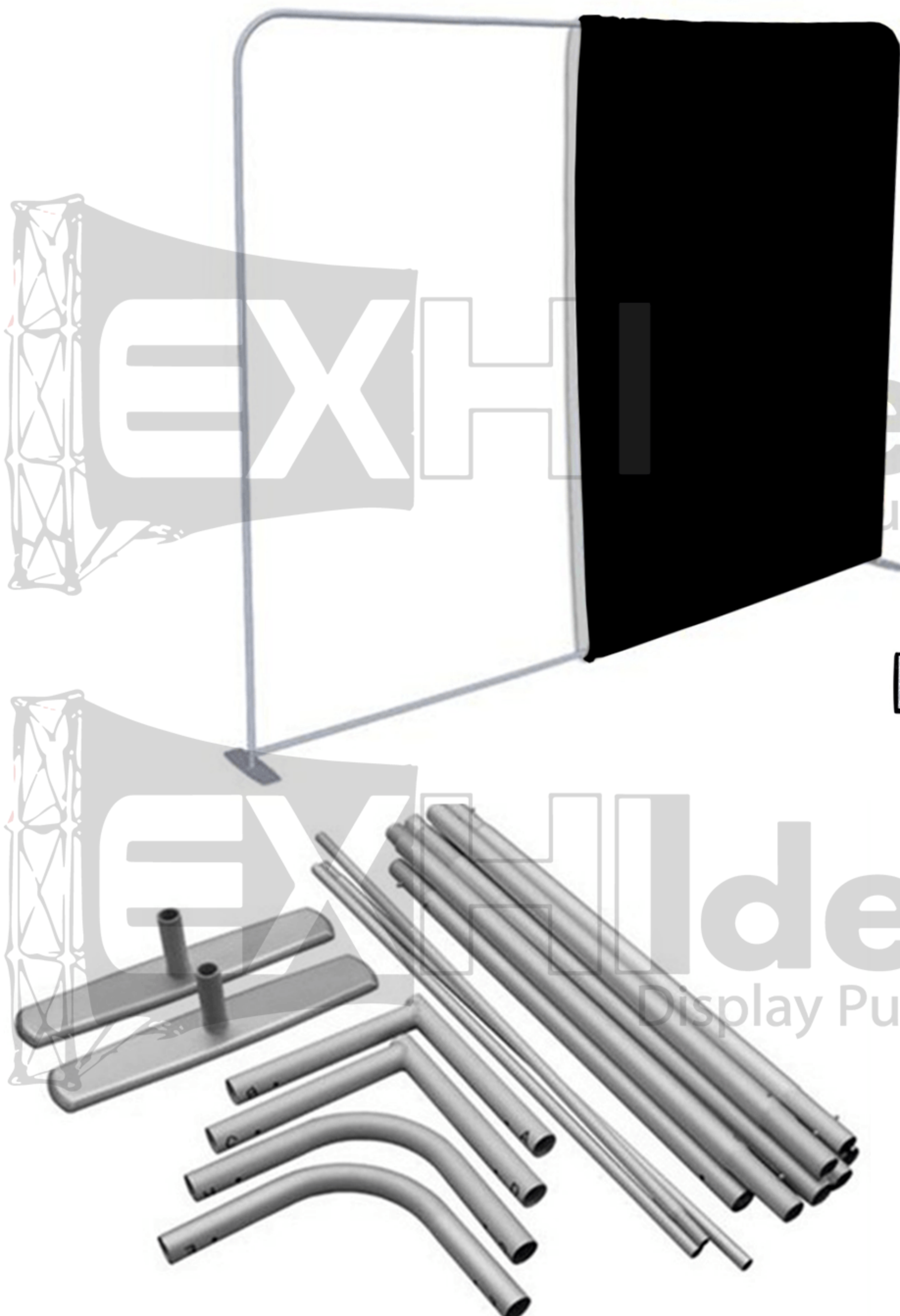

*Incluye Zipper para gráfico



*Lámparas halógenas se venden por separado



*Maleta de transporte incluida

MURO TUBULAR CURVO

Código: TUBE C

Estructura tubular de aluminio ensamblable curvo que moldea el gráfico de tela sublimada (doble vista) medida de 2.29cm * 2.92cm

Peso: 13kg

MURO TUBULAR CURVO

Código: TUBE C 6M

Estructura tubular de aluminio ensamblable curvo que moldea el gráfico de tela sublimada (doble vista) medida de 6.96cm * 2.92m

Peso: 15kg

*Maleta de transporte incluida



Incluye Zipper para gráfico*

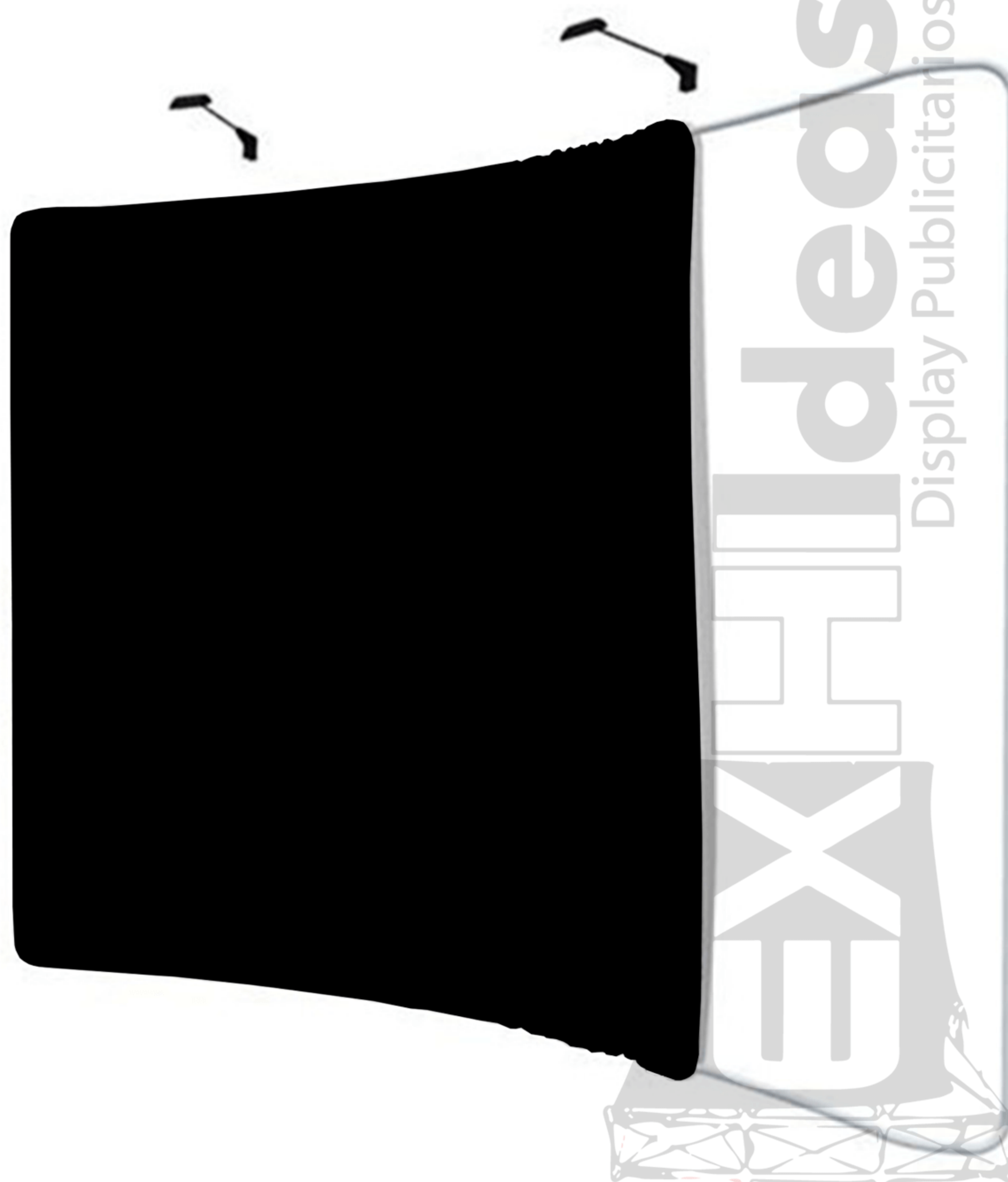

*Lámparas halógenas se venden por separado



REVISTEROS

Para interiores

Estructuras especiales para volantes promocionales, catálogos, revistas e incluso material electrónico.



*Maleta de transporte
incluída



REVISTERO SENCILLO

Código: PCS-SINGL

Estructura tubular de aluminio ensamblable
tela nylon de malla, 4 bolsillos tamaño 21cm * 30cm
altura: 139cm ancho: 30cm

Peso: 1.3kg

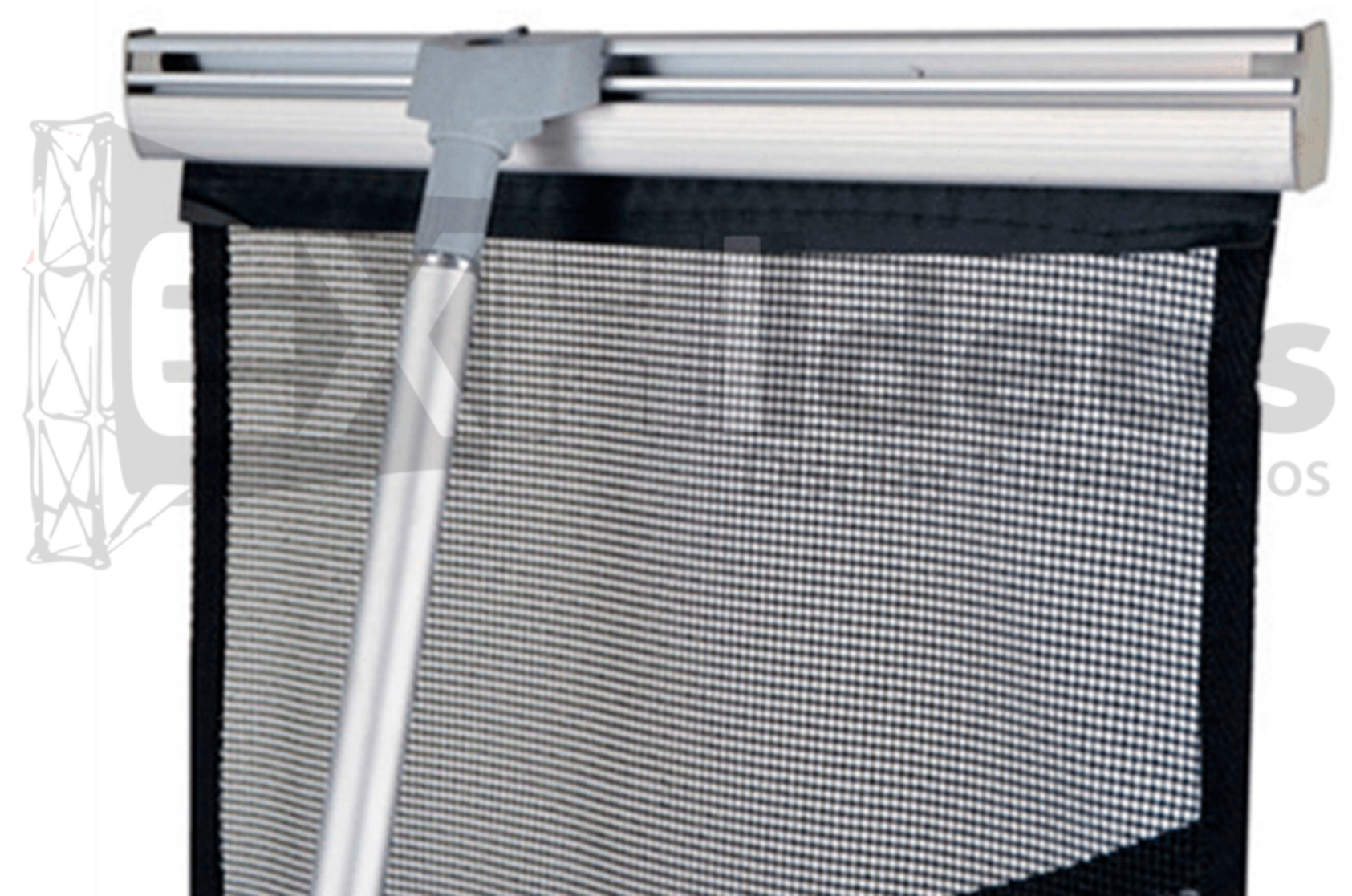
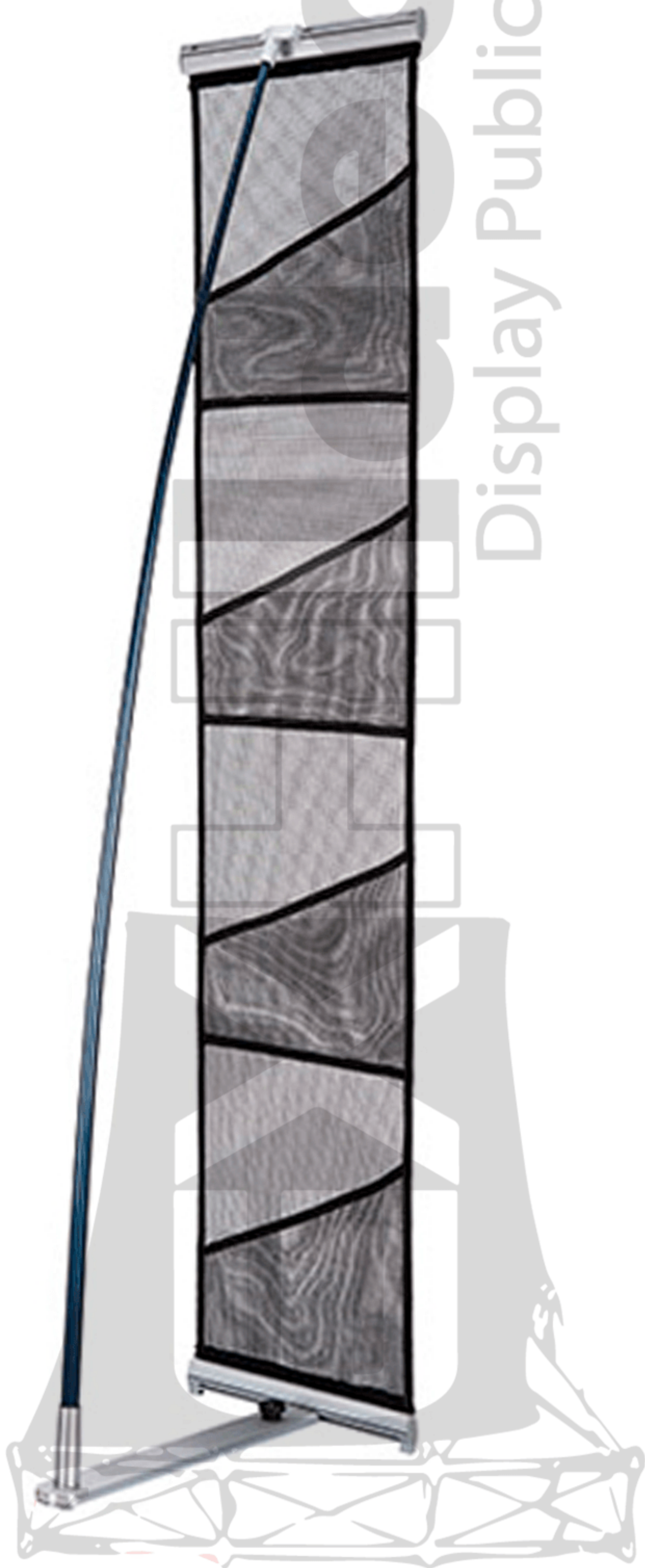



REVISTERO DOBLE

Código: PCS-DOUBLE

Estructura tubular de aluminio ensamblable
tela de red de malla, 8 bolsillos tamaño 21cm * 30cm
altura: 139cm ancho: 54.5cm

Peso: 1.7kg

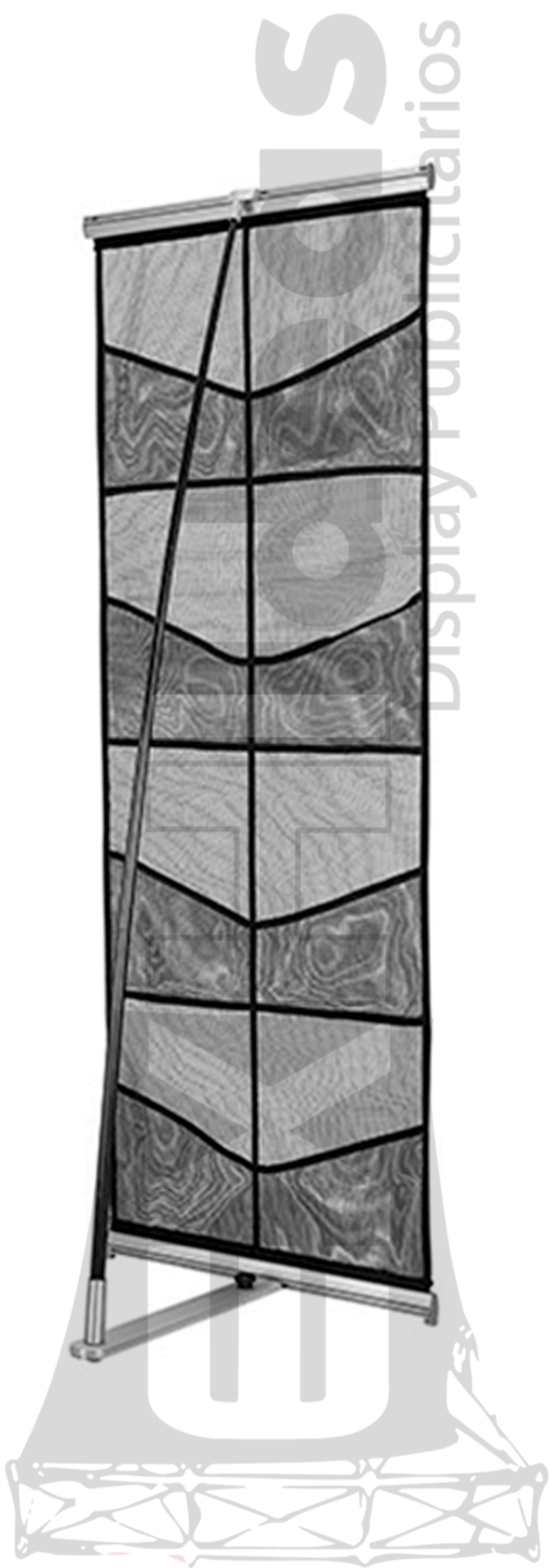

*Maleta de transporte
incluída



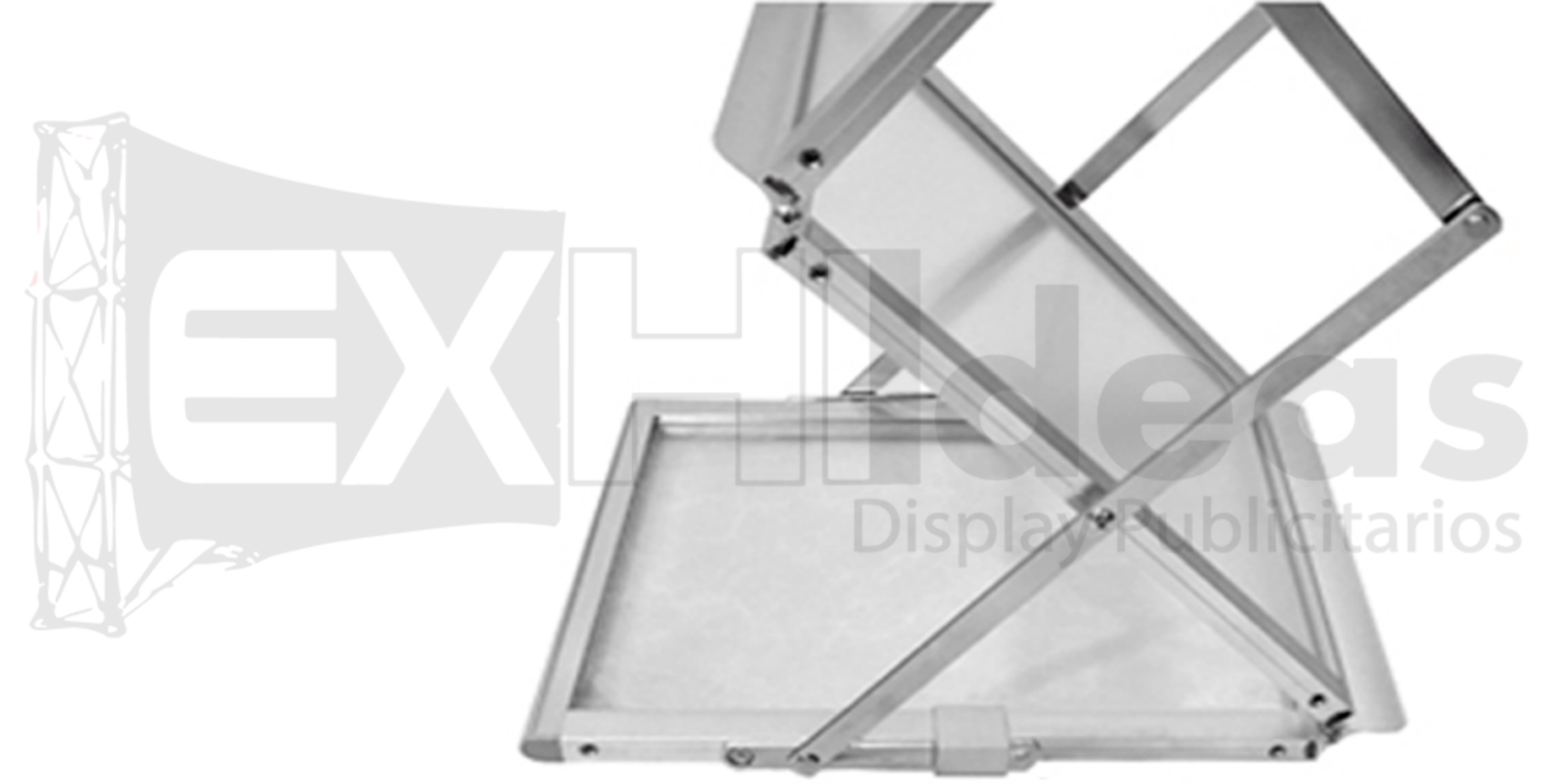

REVISTERO DE ACRÍLICO

Código: REV-ALU

Estructura elegante plegable en forma de Z
marco cromado de acero y aluminio
7 paneles de acrílico 21cm * 30cm
que proporcionan acceso
por los dos lados

Peso: 5.2kg



*Maleta de transporte
incluída



REVISTERO TUBULAR

Código: RV-TELA

Estructura tubular de aluminio ensamblable para forrar con tela sublimada 2 rejillas metálicas altura: 133cm perímetro: 181cm ancho: 45cm

Peso: 5kg

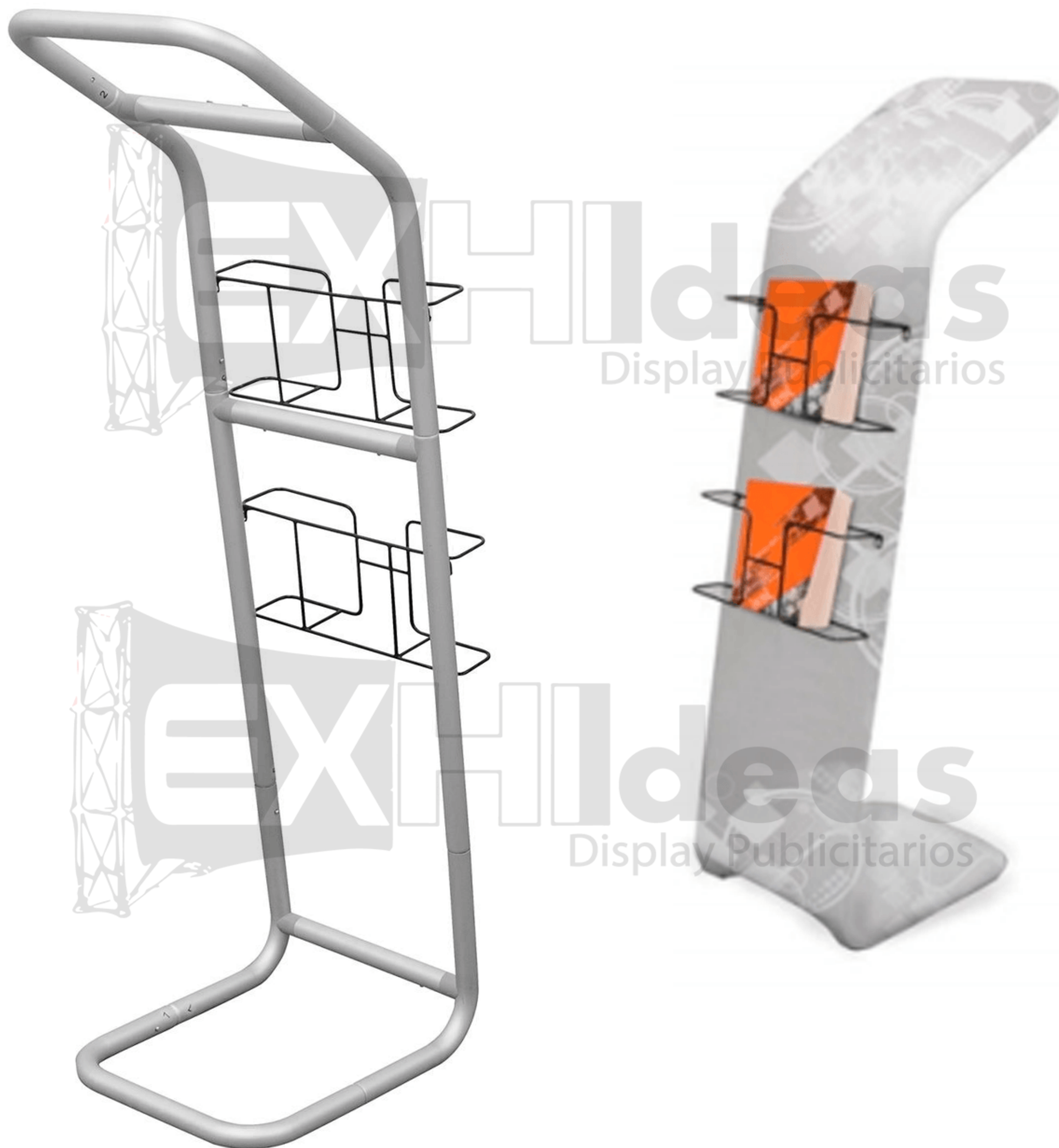

*Maleta de transporte incluida



ISLA TUBULAR CON REPISA

Código: ISLA-TELA

Estructura tubular de aluminio, ensamblable se forra con tela sublimada, doble vista entrepaño de acrílico, base de MDF altura: 204cm ancho1: 85cm ancho2: 85cm

Peso: 5.5kg

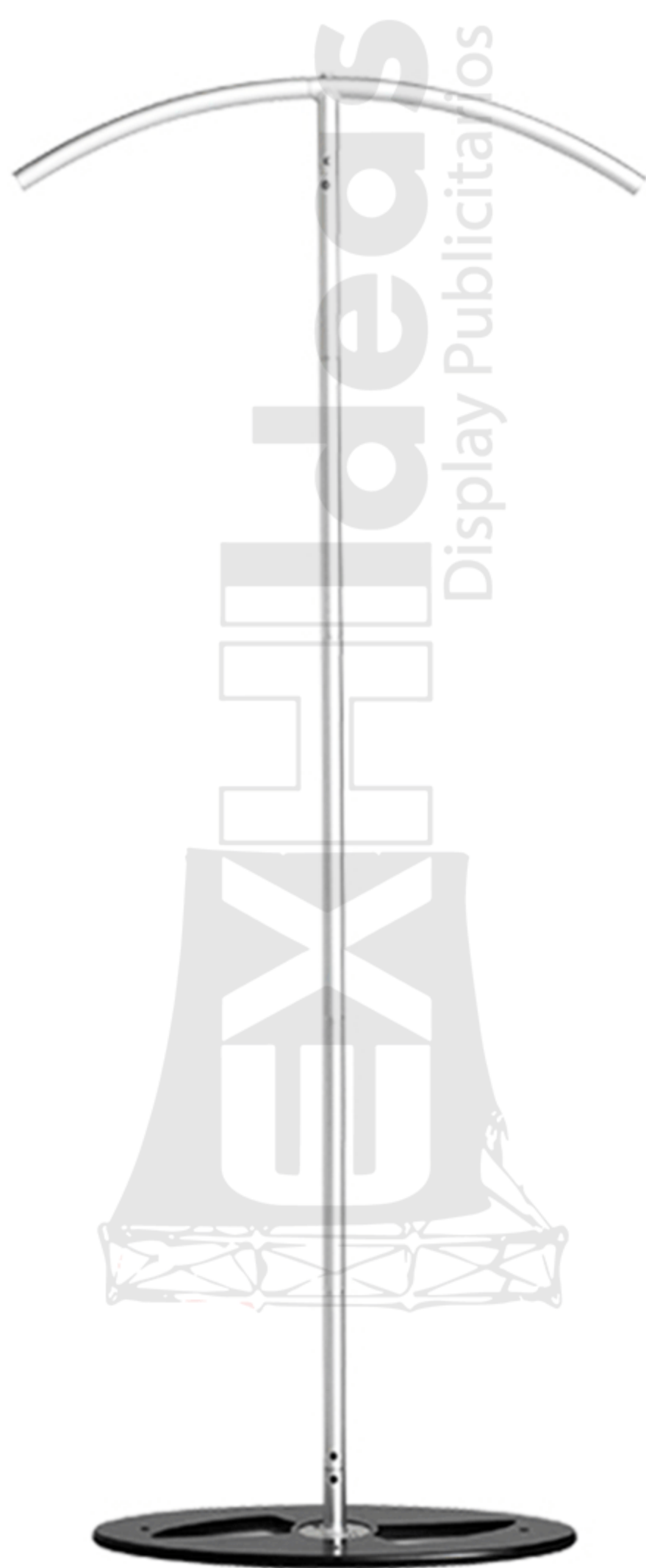

*Lámpara se vende por separado



*ancho1



*Maleta de transporte incluida

*ancho2





TOLDOS

Exteriores/Interiores

Estructura plegable
acero calibre 18 (1,21 mm)
conectores de plástico y pies de acero que
cuentan con agujeros especiales para
clavijas.

Puede llevar tela impermeable lisa o sublimada.

EXHIdeas
Display Publicitarios

Maleta
de transporte
se vende
por separado*



*Tela impermeable
se vende por separado
resistente al sol y lluvia
se puede lavar y sublimar
Colores disponibles:

*Azul
Blanco
Rojo*

EXHIdeas

TOLDO 2X2M

Código: tent

Estructura plegable de acero calibre 18
conectores plásticos y pies de acero
práctico y muy resistente al viento
abarca el espacio de 2 metros cuadrados

EXHIdeas
Display Publicitarios



TOLDO 3X3M

Código: TENT 3MX3

Estructura plegable de acero calibre 18
conectores plásticos y pies de acero
práctico y muy resistente al viento
abarca el espacio de 3 metros cuadrados



*Maleta
de transporte
se vende
por separado



*Tela impermeable
se vende por separado
resistente al sol y lluvia
se puede lavar y sublimar
Colores disponibles:
Azul
Blanco
Rojo



*Tela impermeable
se vende por separado
resistente al sol y lluvia
se puede lavar y sublimar
Colores disponibles:

Azul
Blanco
Rojo



TOLDO 3X6M

Código: TENT 3MX6

Estructura plegable de acero calibre 18
conectores plásticos y pies de acero
práctico y muy resistente al viento
abarca el espacio de 3 x 6 metros cuadrados



*Maleta
de transporte
se vende
por separado



EXH Ideas
Display Publicitarios

*Incluye una
pestaña



*Tela se vende por
separado



TOLDO COPULA 3X3

Código: TOL 3X3 CUPULA

Estructura pentagonal ensamblable
de aluminio 3.81 cm resistente al viento
altura de entradas: 2.2 m
altura total: 5 m

Peso: 28kg



EXH Ideas
Display Publicitarios



*Incluye una
pestaña



*Tela se vende por
separado



TOLDO COPULA 4.5 X 4.5

Código: TENT 4.5X4.5 CUPULA

Estructura pentagonal ensamblable
de aluminio 3.81 cm resistente al viento
altura de entradas: 2.2 m
altura total: 7.5 m

Peso: 28kg





COLGANTES

Interiores

Estructuras ensamblable de aluminio se forran con tela, ligeras y elegantes

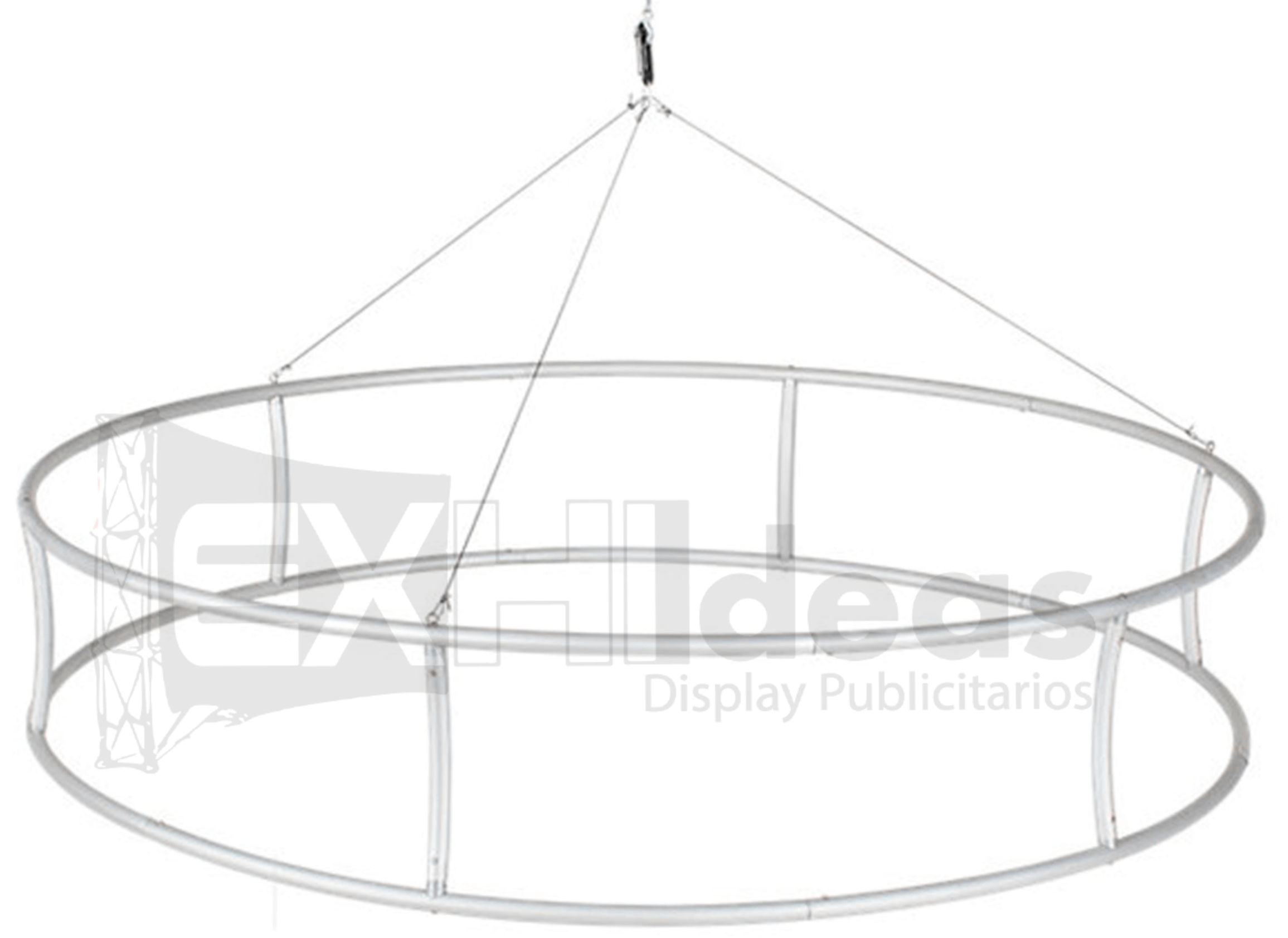

COLGANTE CIRCULAR

Código: COLGANTE-C

Estructura circular ensamblable de aluminio para colgar en estructuras y techos se forra con tela, impresion doble vista incluye maleta de transporte

10.3 metros de alambre de acero, gancho y zipper para tela
7 metros de diámetro 1.07 metros de altura

Peso: 9.5kg



*Maleta de transporte incluida

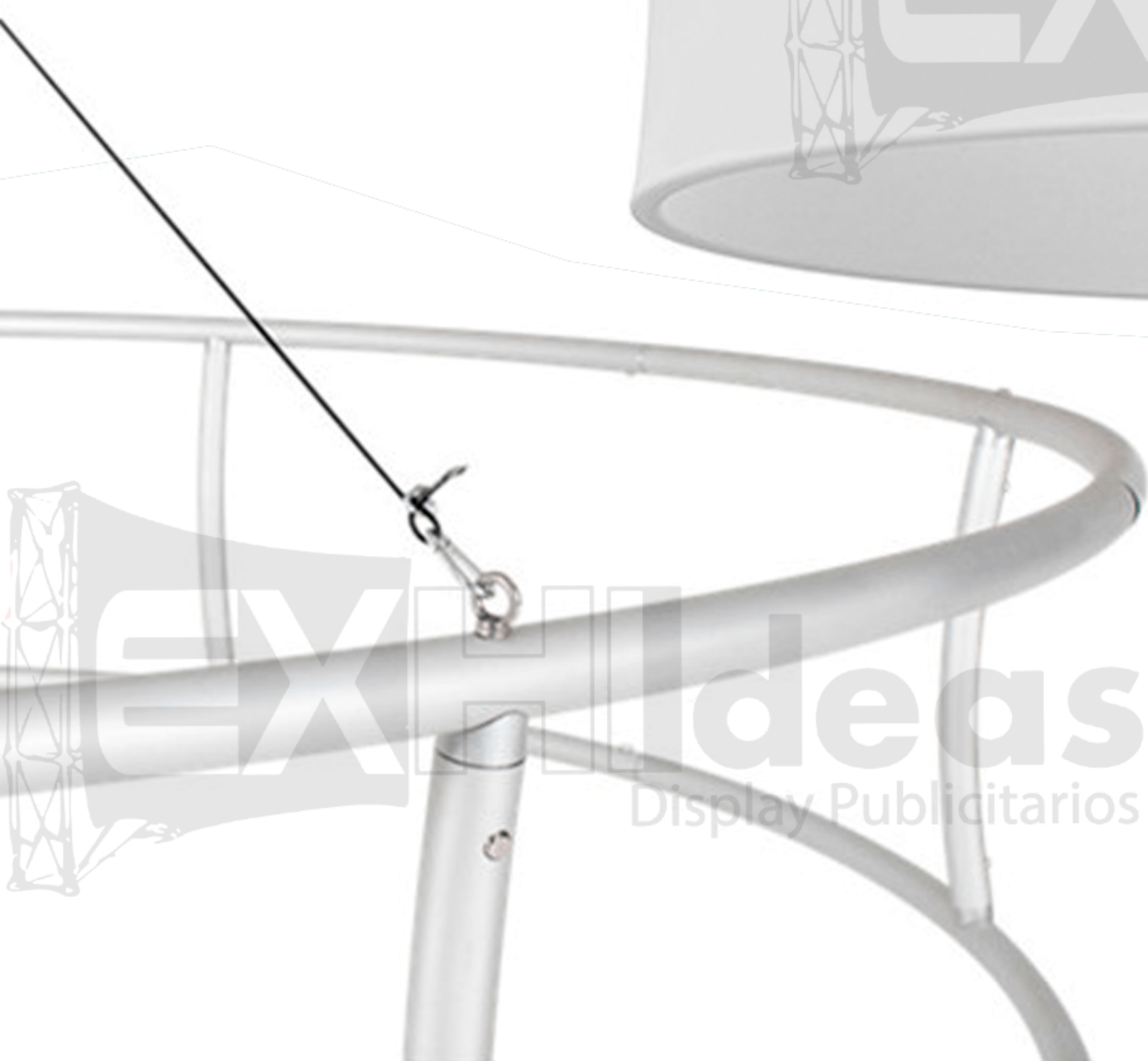

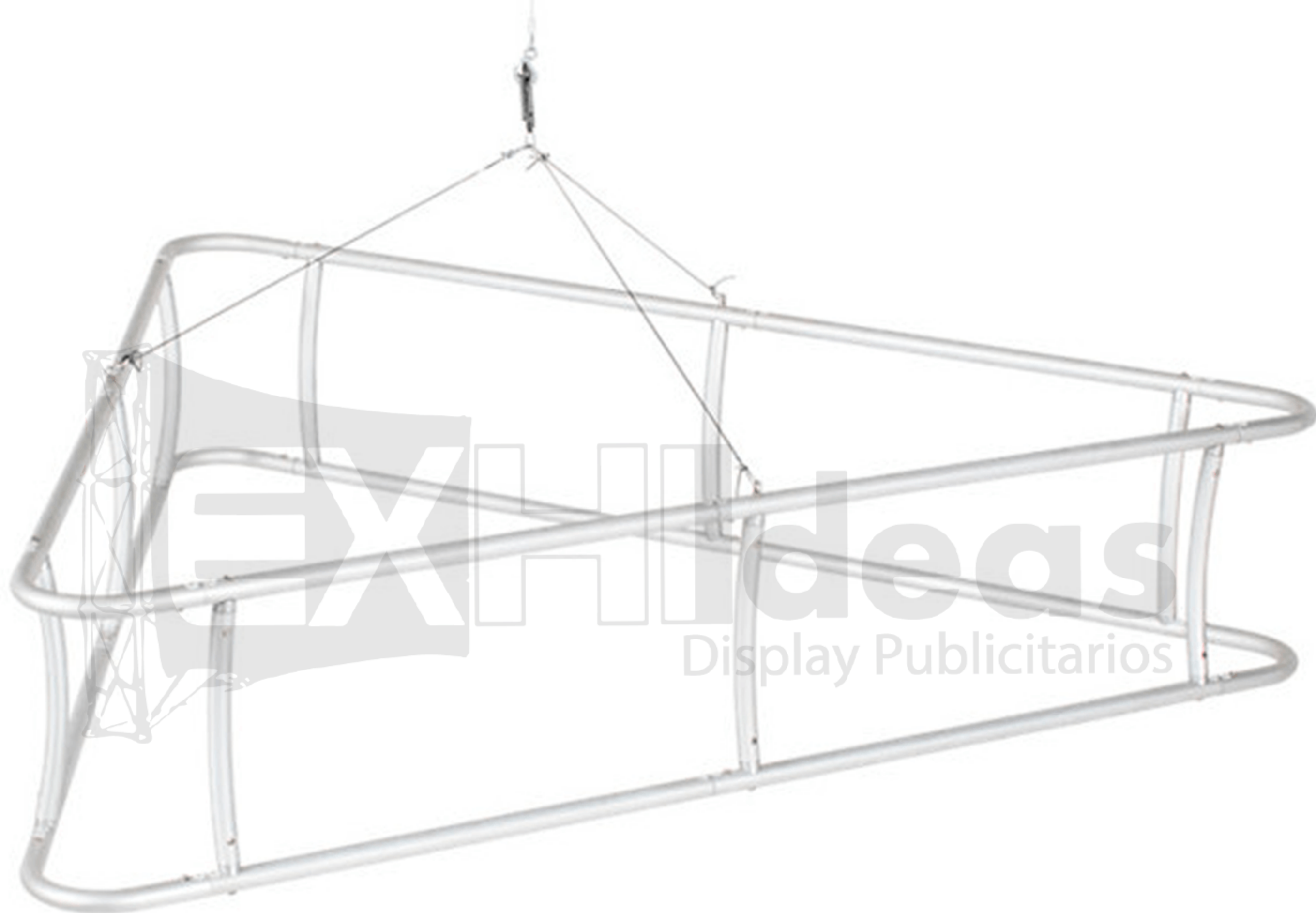

*Maleta de transporte
incluída

COLGANTE TRIANGULAR

Código: COLGANTE-T

Estructura triangular ensamblable de aluminio
para colgar en estructuras y techos
se forra con tela, impresion doble vista
incluye maleta de transporte

10.3 metros de alambre de acero, gancho y zipper para tela
3 metros por lado 1.07 metros de altura

Peso: 9.5kg





COLGANTE BANNER

Código: COLGANTE 60X90

Estructuras riel de aluminio grueso
colgantes plásticos
medida de 60cm * 90cm

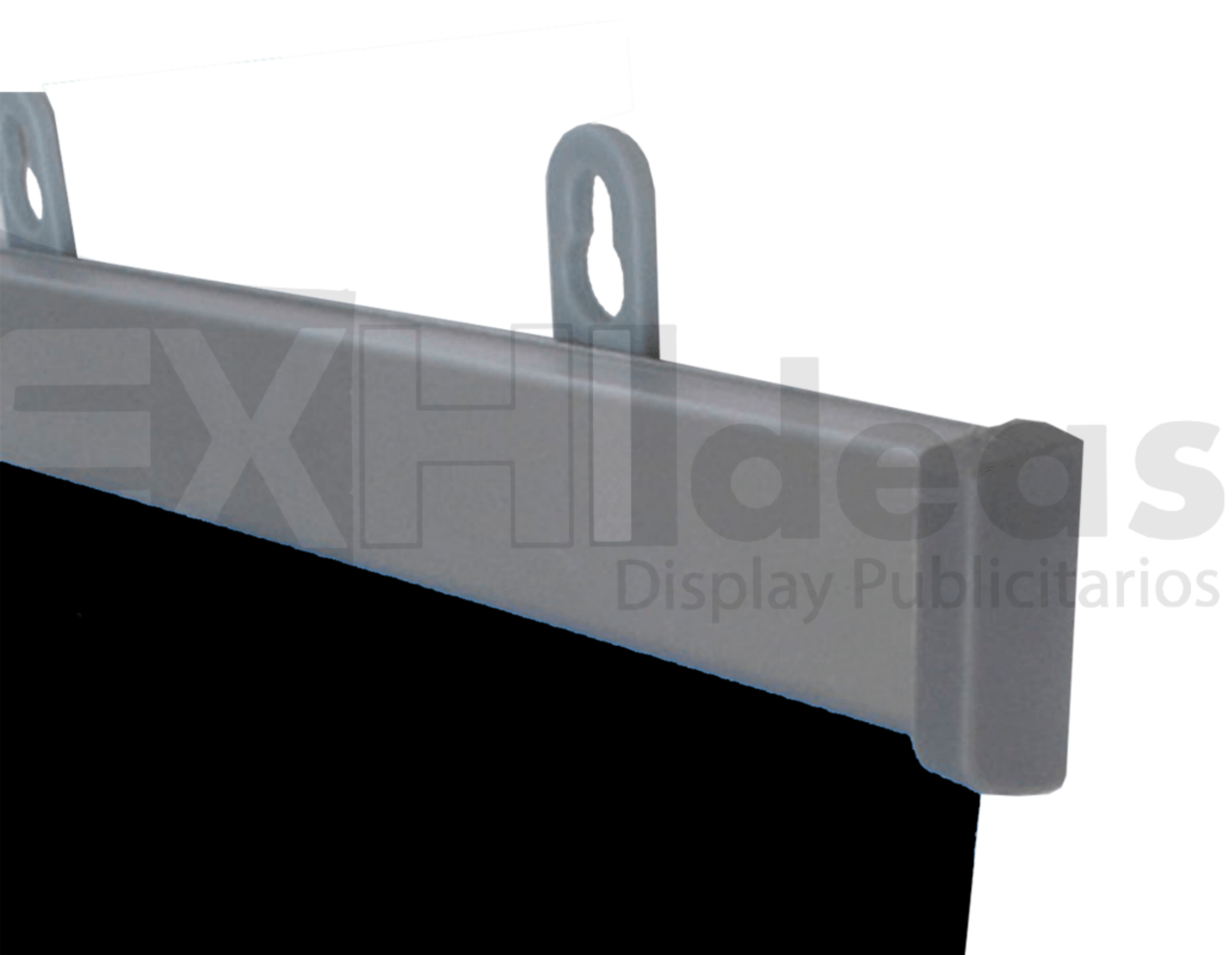
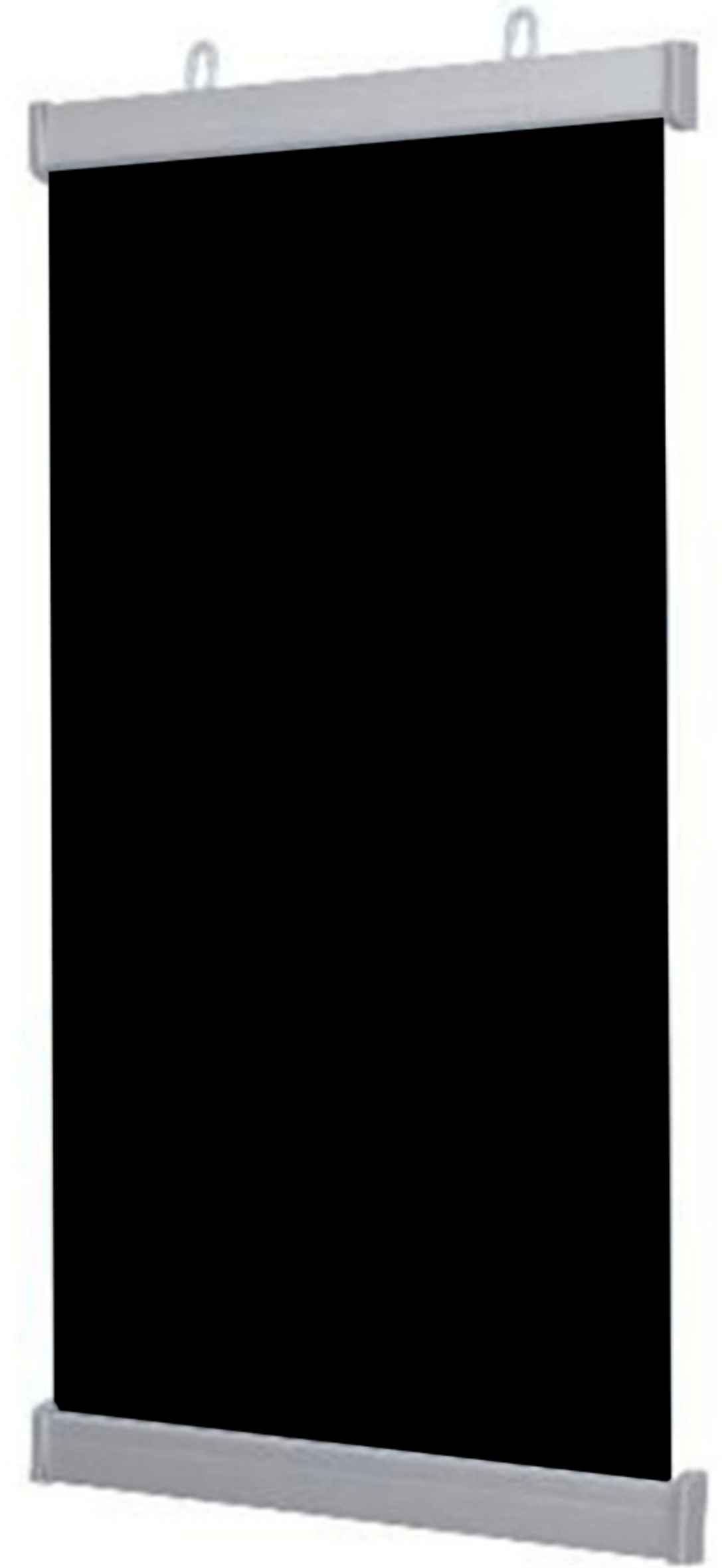



STAND PACK

Interiores

Paquetes de stands, especiales para ferias exposiciones publicitarias o reuniones.

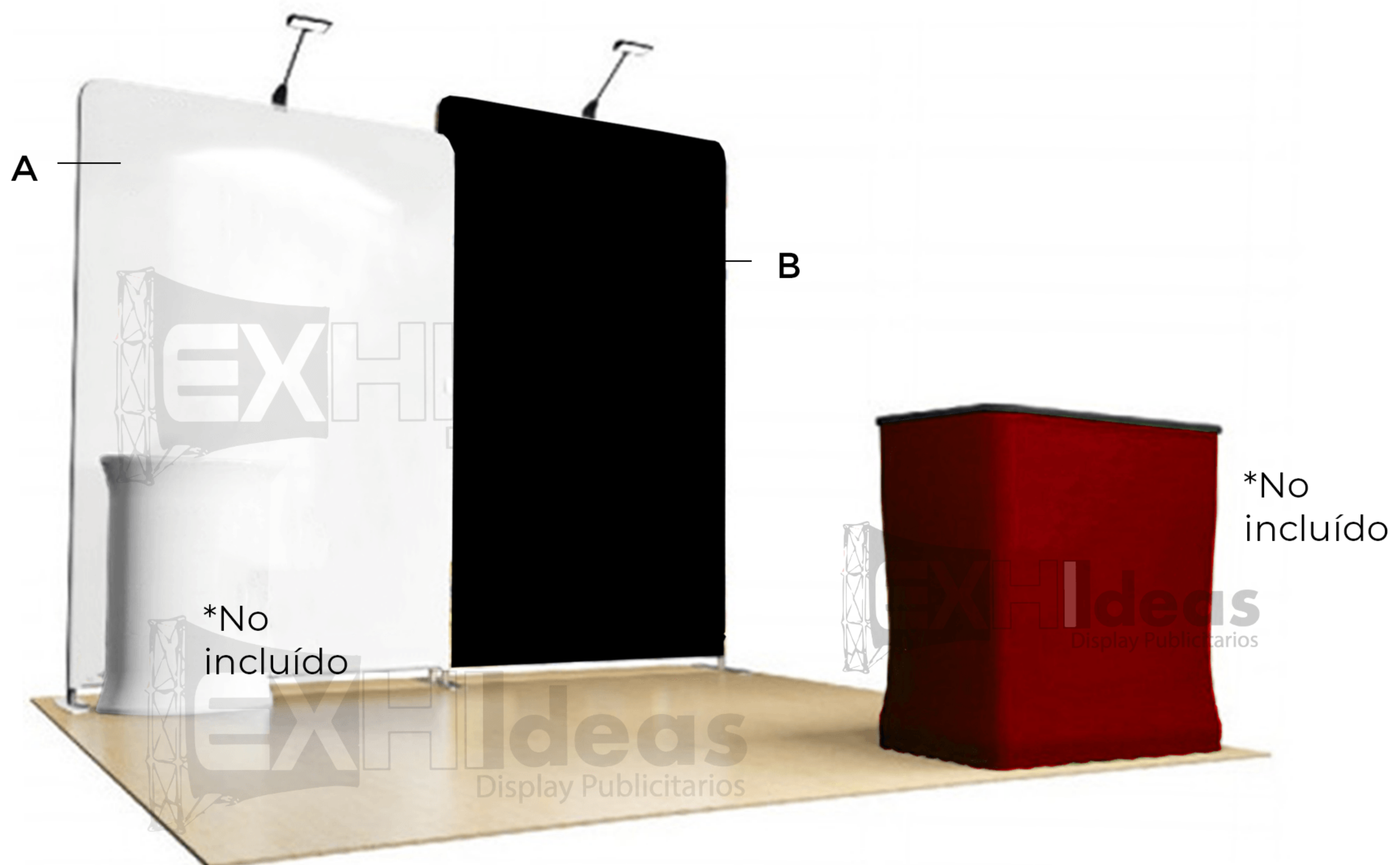

*Lámparas halógenas se venden por separado



PAQUETE TUBULAR

Código: PACK1

El paquete consta de 2 paredes tubulares de aluminio
 A: 1.45m * 2.29m & B: 1.45m * 2.46m
 se forran con tela (puede ser doble vista)
 incluye zipper para tela
 especial para Stand de 3 metros de fondo

Peso: 9.5kg



*Maleta de transporte incluida



*Lámparas halógenas se venden por separado

PAQUETE TUBULAR

Código: PACK 1002

El paquete consta de 2 paredes tubulares de aluminio
A: 1.45m * 2.46m & B: 1.45m * 2.46m
se forran con tela (puede ser doble vista)
incluye zipper para tela
especial para Stand de 3 metros de fondo

Peso: 9.5kg



*Maleta de transporte incluida

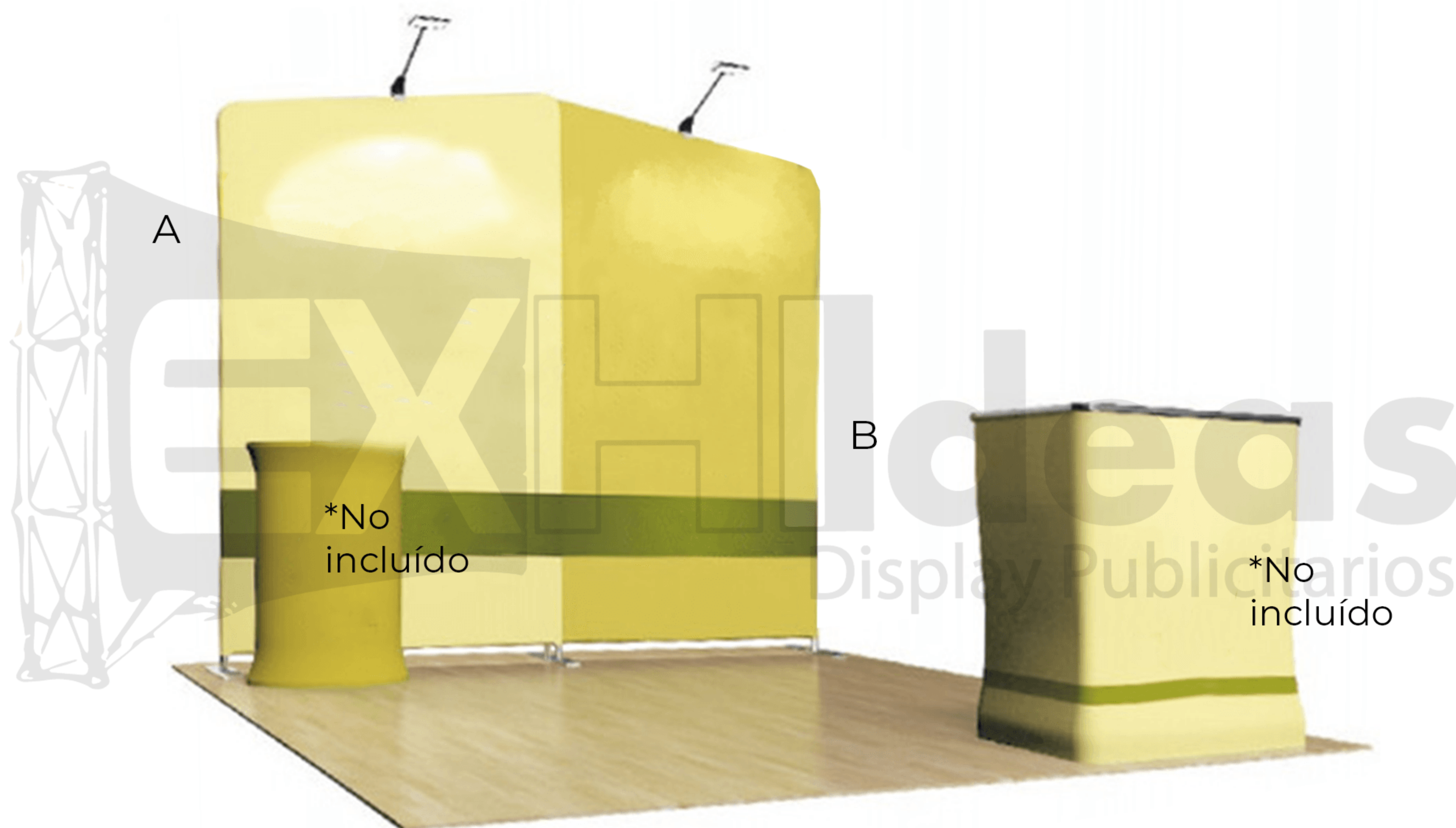

*No
incluído

*No
incluído



*Lámparas
halógenas se venden por separado



PAQUETE TUBULAR

Código: PACK 1003

El paquete consta de 2 paredes tubulares de aluminio con inclinación
 A: 1.45m * 2.46m & B: 1.45m * 2.46m
 se forran con tela (puede ser doble vista)
 incluye zipper para tela
 especial para Stand de 3 metros de fondo

Peso: 9.5kg



*Maleta de transporte
incluída



*Lámparas halógenas se venden por separado

PAQUETE TUBULAR

Código: PACK 2004

El paquete consta de 3 paredes tubulares de aluminio
 1: 2m * 2.29m 2: 2m * 2.29m 3: 2m * 2.29m
 se forran con tela (puede ser doble vista)
 incluye zipper para tela
 especial para Stand de 6 metros de fondo

Peso: 14.5kg



*Maleta de transporte incluida

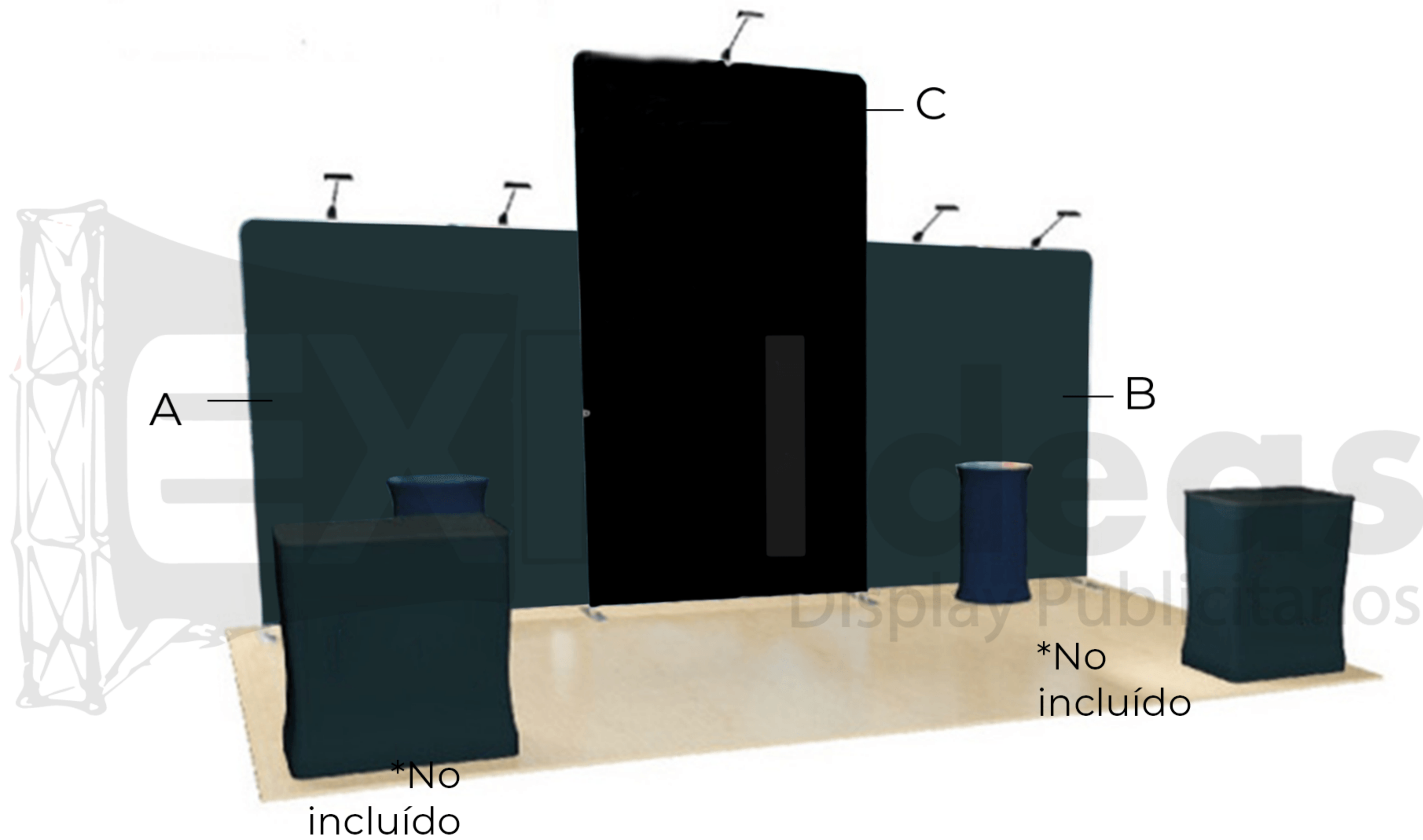

*Lámparas halógenas se venden por separado



PAQUETE TUBULAR

Código: PACK 2008

El paquete consta de 3 paredes tubulares de aluminio
 A: 2m * 2.29m B: 2m * 2.29m C: 2m * 3.29m
 se forran con tela (puede ser doble vista)
 incluye zipper para tela
 especial para Stand de 6 metros de fondo

Peso: 14.5kg



*Maleta de transporte incluida

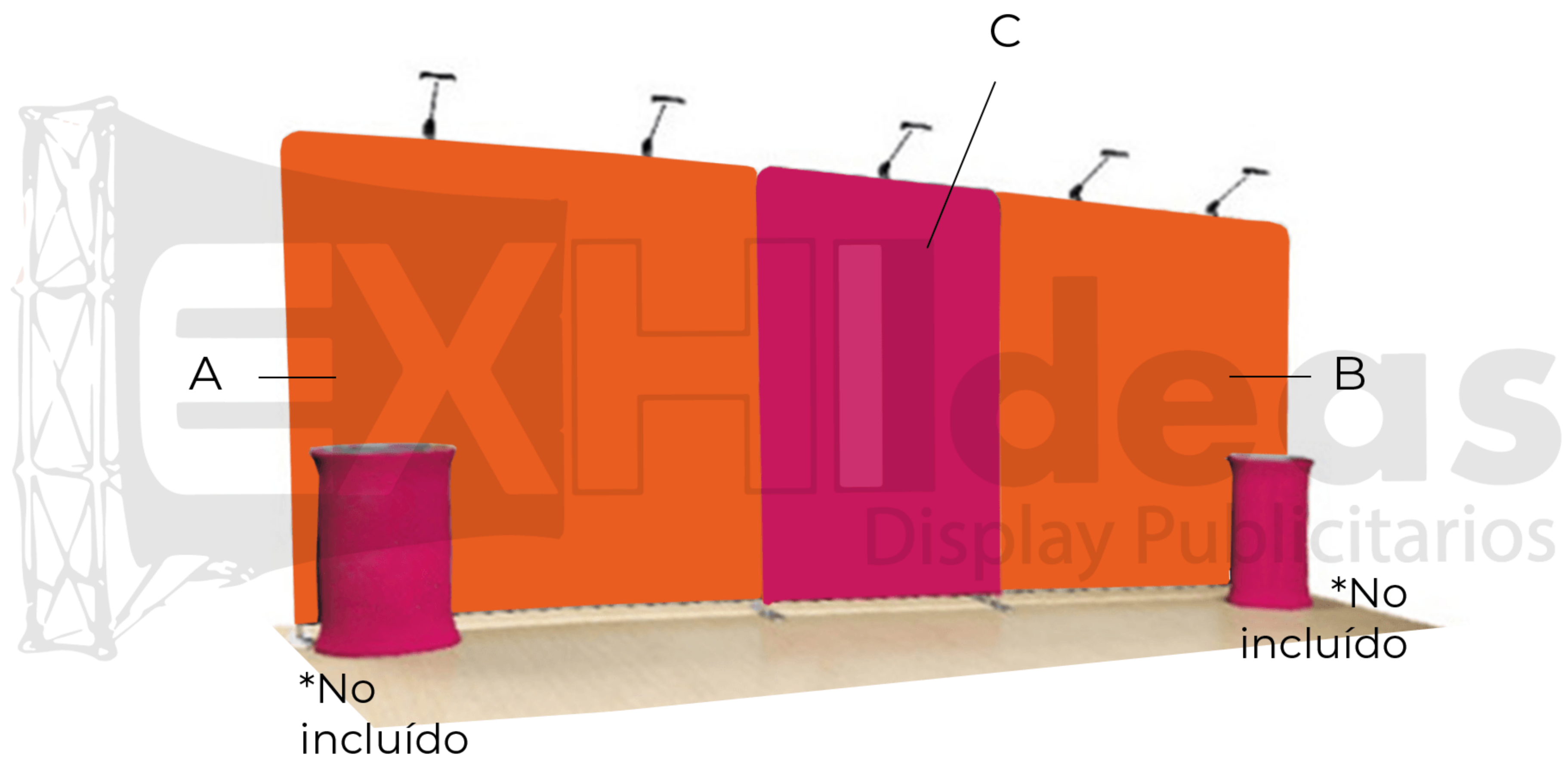

*Lámparas halógenas se venden por separado

PAQUETE TUBULAR

Código: PACK 2002

El paquete consta de 3 paredes tubulares de aluminio
 A: 2.26m * 2.29m B: 2.26m * 2.29m C: 1.10m * 2.29m
 se forran con tela (puede ser doble vista)
 incluye zipper para tela
 especial para Stand de 6 metros de fondo

Peso: 14.5kg



*Maleta de transporte incluida

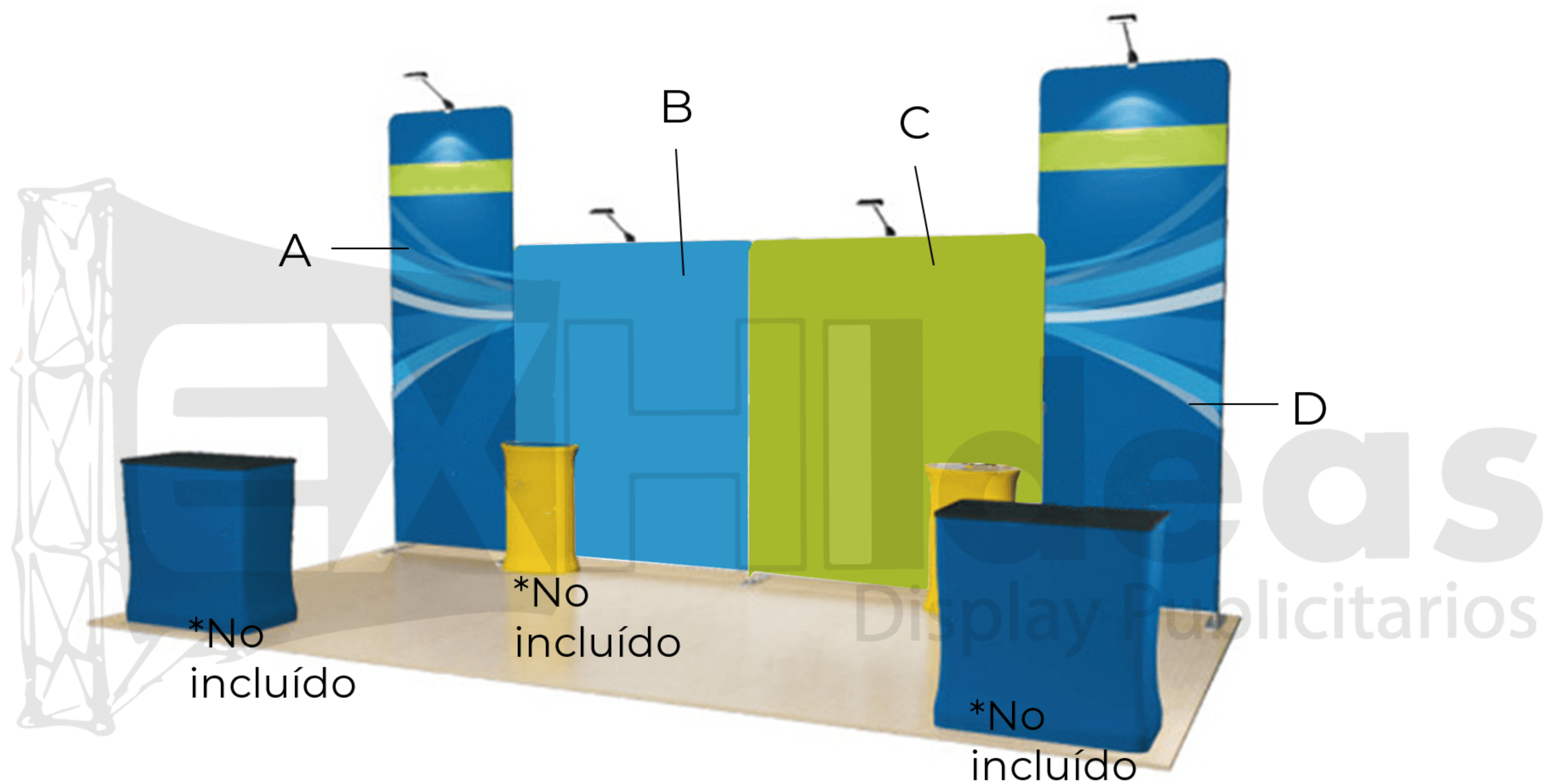

*Lámparas halógenas se venden por separado



PAQUETE TUBULAR

Código: PACK 2012

El paquete consta de 4 paredes tubulares de aluminio
 A&D: 1m * 3.29m B&C: 2m * 2.29m
 se forran con tela (puede ser doble vista)
 incluye zipper para tela
 especial para Stand de 6 metros de fondo

Peso: 14.5kg



*Maleta de transporte incluida



EXHIDEAS CUENTA CON REPUESTOS DE TODOS SUS PRODUCTOS

Facilitando el mantenimiento de cualquiera de las estructuras





Oficinas: 333 613 7920
WhatsApp: 333 475 6868

Matriz
Av. Alemania #1216 Colonia Moderna CP: 44190
Guadalajara, Jalisco, México.